

Government of India
Ministry of Defence

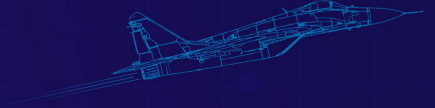

Department of
Defence Production

75
Azadi Ka
Amrit Mahotsav

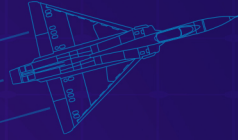

AI² Def

ARTIFICIAL INTELLIGENCE IN DEFENCE 

THE NEW AGE OF DEFENCE

Presenting AI Preparedness of the Country in Defence



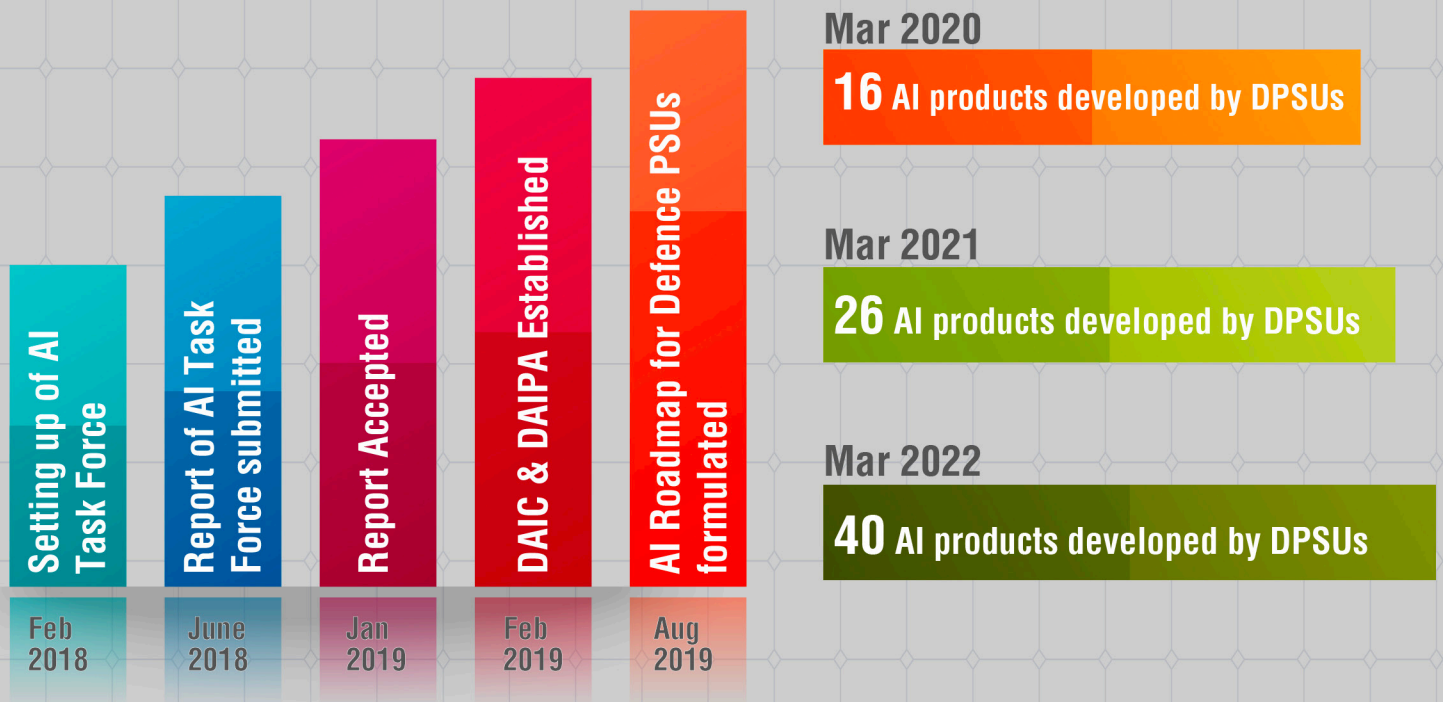



सत्यमेव जयते

प्रधान मंत्री
Prime Minister

MESSAGE

It is heartening to learn about 'AiDef', an event to showcase remarkable efforts by various defence organizations and startups. This initiative on Artificial Intelligence in Defence, organized by Department of Defence Production, Ministry of Defence is appreciable. The gesture to publish a booklet on Artificial Intelligence (AI) to mark the occasion is thoughtful.

Defence sector is among the foremost priorities of our Government. During the last 8 years, we have taken several initiatives to modernise and strengthen our defence forces. From decisive steps in the defence sector to adopting a technology-driven approach and instilling unparalleled transparency in processes, we are resolute in our efforts to further our defence preparedness.

Technology opens up new avenues and opportunities for growth. Technology has propelled every sphere of activity and today holds the key to enhance the strength, speed and scale of our efforts to further self-reliance in defence sector and make our defence sector future-ready.

In a rapidly changing global environment, Artificial Intelligence, Robotics and Machine Learning have tremendous potential to enhance the efficiency and response capabilities of our defence forces. We are firm in our endeavour for developing a vibrant ecosystem from research, design and development to manufacturing within the country, as it is crucial to promote customization and uniqueness of our defence systems for a strategic edge over the adversaries.

Cyber security today has moved beyond the digital world and has become a subject of national security. In this context, our formidable IT power needs to be deployed in the defence sector.

AI-based products and systems enable quicker decision-making. We are striding forward with our efforts to make India a global hub for AI. In this context, AiDef provides a vibrant platform to various stakeholders in the defence sector to showcase latest AI products.

The deliberations at the event will provide the participants an opportunity to share diverse experiences and come forward with new ideas.

Best wishes for all success of AiDef.

(Narendra Modi)

New Delhi
आषाढ 17, शक संवत् 1944
8th July, 2022



**Specific targets given
to DPSUs for Ai product
development**

User review conducted

**Rs.100 crore allocated
by each service for AI
implementation**

**AI infrastructure for
storage and computing
under creation**

राजनाथ सिंह
RAJNATH SINGH



MESSAGE

D.O.NO.1119/FRM/2022

रक्षा मंत्री
भारत
DEFENCE MINISTER
INDIA

Artificial Intelligence (AI) is widely acknowledged to be one of the most dramatic technological game changers of our age. It is already starting to have a disruptive impact on most walks of private and public life. Defence and security are no exception. Leading countries around the globe are investing huge resources, to tap the benefits of AI in the Defence and Aerospace sector.

Artificial Intelligence can contribute immensely towards Atmanirbhar Bharat Hon'ble Prime Minister, Shri Narendra Modi, has emphasised on the need to "Make Artificial Intelligence in India and Make Artificial Intelligence work for India".

In keeping with this vision of Hon'ble Prime Minister, Defence AI Council (DAIC) was created for providing necessary guidance to enable and effect development of operating framework, policy level changes and structural support for AI adoption.

Our Services and Research Organisations are working together in close coordination with industry and Start-ups to develop state-of-the-art AI solutions.

I call upon all stakeholders to join hands to make India a world leader in the field of AI in Defence to support the Armed Forces and work for the security of the nation.

Date: 06 July, 2022
Place: New Delhi

(Rajnath Singh)

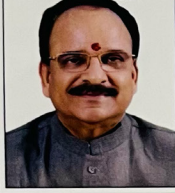

रक्षा एवं पर्यटन राज्य मंत्री
भारत सरकार
Minister of State for Defence and Tourism
Government of India

MESSAGE

Artificial Intelligence has infiltrated practically into every civilian industry we can imagine. It has changed the way people and businesses work, and it is now swiftly becoming a necessary component of modern combat. Modern militaries are actively pursuing AI research in the fields of intelligence collection and analysis, cyber operations, information operations, command and control, and for use in a variety of autonomous vehicles.

Progress in AI allows new capabilities that will affect military strategies assertively. The implications of these developments will be felt across the array of military criteria from knowledge, surveillance and identification to balances of offense and defence.

To make India a reckoning force in the field of AI in Defence, a beginning was made in 2018 to nurture the potential of AI in Indian Defence. Last three years have been a tremendous journey of technological evolution by our Services and Industry to make country leap frog in innovative technology development.

Building on these initial steps, I sincerely hope this book contributes to a more fundamental rethink of how AI may affect the future of defence and security and also how our Services and Industry can responsibly harness development in this field to achieve more sustainable defence and security solutions.

(Ajay Bhatt)

Station: New Delhi

Dated: 06th Jul, 2022

डा. अजय कुमार
सचिव
Dr. Ajay Kumar
Secretary



भारत सरकार
रक्षा मंत्रालय
रक्षा उत्पादन विभाग
नई दिल्ली - 110 011
Government of India
Ministry of Defence
Department of Defence Production
New Delhi - 110 011
Tel. : 23012527 (O) 23012300 (Fax)



MESSAGE

Artificial Intelligence (AI) is re-defining the modern warfare. The progress in Artificial Intelligence is bringing around new potential in defence technology. By taking advantage of AI technology in defence, the performance of forces can be enhanced as such technologies improve computational and decision making skills.

Our vibrant software industry and growing start-up ecosystem has contributed immensely to the rapid progress in AI applications. The growing focus of the Government on the defence sector will further stimulate development AI enabled solutions for the services.

Government, through Defence AI Project Agency (DAIPA) has already prepared a roadmap for development of AI enabled applications in Defence Public Sector Undertakings covering areas of Cyber Security, Surveillance, Training and Simulation, Predictive Maintenance, Multi-Sensor Data Fusion etc.

This book has been curated to showcase the grounds already covered by our organisations and services in the arena of AI to boost a strong self defence system. I hope this book will motivate private industry & Start-ups to come forward and collaborate with Government institutions to develop new applications for a stronger defence of the nation.

'JAI HIND'

(Ajay Kumar)

Place : New Delhi
Date : 1st July, 2022

Government of India
Ministry of Defence



Department of
Defence Production

75
Azadi Ka
Amrit Mahotsav

A stylized map of India is formed by a network of white nodes connected by thin white lines, set against a dark blue background. A bright, multi-colored light beam (yellow, orange, red) emanates from the northern part of the map. In the background, there are faint, large-scale geometric patterns, including a gear-like circular structure and a large number '75'.

INDIAN INTELLIGENCE MAKES RAPID STRIDES IN ARTIFICIAL INTELLIGENCE

The Indian Defence industry is taking giant steps in transforming the armed forces into one of the most advanced in the world. The adoption of technology based on Artificial Intelligence (AI) will revolutionise the Indian Military. It also places India firmly in the huge defence product market.

Government support and plans to modernize the military through AI is a result of years of groundwork. Bold policies, dedicated budgets, policy changes and the thrust towards indigenisation, have helped create an atmosphere of cutting-edge innovation and collaboration.

This joint effort among industry both public and private, research organisations, academic institutions, start-ups and innovators has helped create many unique technological products based on AI in the areas of data, logistics, surveillance, weapons and many more.

The introduction of autonomy in weapon systems, in ISR (Intelligence, Surveillance and Reconnaissance), data management, can be a huge asset in stopping terrorism, installing counter-terrorism measures, protecting soldiers. In fact, AI in defence can change combat and conflict at the deepest levels.

This book is a compendium of some stupendous products and stellar achievements in AI-based technologies in defence by individuals, companies and institutions towards catapulting the Indian defence industry into a major global force.



INDEX



→ AI Platform Automation

01	Deepcatch Edge AI Platform	08
02	Merlin MLOps	09
03	iSentinel.ai	10
04	System of Disseminated Parallel Control Computing In Real Time (DPCC)	12

→ Autonomous / Unmanned/ Robotic Systems

05	Sapper Scout – Mine Detection UGV	15
06	AI Capability in Swarm Drones	16
07	Project Drone Feed Analysis – AI based RPA feed and data analysis	17
08	Silent Sentry (Rail Mounted Robot with AI)	19
09	Autonomous Fast Intercept Boat (AFIB)	21
10	Project Storm Drone (Automated Room Intervention Drone)	22
11	Cognitive Radar	24
12	AI-Enabled Remotely Operated Vehicle (ROV)	25
13	HR Chatbot 'Anvesha'	26
14	AI-Powered Unmanned Ground Vehicle	27

→ Block chain based Automation

15	Permissive Block Chain Mechanism	29
----	----------------------------------	----

→ Command, Control, Communications, Computer and Intelligence, Surveillance and Reconnaissance Systems (C4ISR) Systems

16	AI-Based Intercept Management System (IMS)	31
17	AI-Based Motion Detection & Target Identification System in LC	32
18	Continuously Observing Ubiquitously Available AI-Surveillance System	33
19	AI-Enabled Airborne Electro-Optic Infrared System	34
20	Deep Learning Toolkit for Aerospace and Defence	35
21	Adversary Network Analysis Tool (ANANT)	36
22	Target Tracking for Complex Naval Scenarios	37
23	Animal Detection for Railways	38
24	Enemy Aircraft Activity Recognition & Classification	39
25	AI-Based Anomaly Detection for Maritime Domain	40
26	Passive Ranging using AI as a Classifier	41
27	AI Based Passive TWS (Track While Scan) System	42
28	Development of Machine Algorithms for Maritime Anomaly Detection	43
29	Enhancing UDA by use of AI/ML and other Novel Techniques	44
30	AI/Big Data for Acoustic and Magnetic Signature Analysis	45

→ Cyber Security

31	Android Malware Detection Solution	47
----	------------------------------------	----

INDEX



→ Human Behavioural Analysis

- | | | |
|----|----------------------------------|----|
| 32 | Driver Fatigue Monitoring System | 49 |
|----|----------------------------------|----|

→ Intelligent Monitoring Systems

- | | | |
|----|--|----|
| 33 | Project Seeker – Facial Recognition System for Population Monitoring, Surveillance and Garrison Security | 51 |
| 34 | V-logger Vehicle Tracking System | 53 |
| 35 | Face Recognition System under Disguise | 55 |
| 36 | Segmentation of Satellite Panchromatic Videos | 56 |
| 37 | AI based 360° Surrounding View Monitoring System | 57 |
| 38 | HUMS Ground Station | 58 |
| 39 | AI-Based Satellite Image Analysis | 59 |
| 40 | AI-Based Technique for Prediction of Atmospheric Visibility | 60 |
| 41 | Chimera-22 Smart Camera | 61 |
| 42 | DeepSight Canopy Inspection for Fighter Jets | 62 |

→ IoT / Smartcities

- | | | |
|----|---|----|
| 43 | Internet of Battle Things (IoBT): Smart Helmets | 64 |
| 44 | Automatic Number Plate Recognition for Smart Cities | 65 |
| 45 | AI Enabled Adaptive Traffic Optimization Solution | 66 |

→ Lethal Autonomous weapon systems

- | | | |
|----|--|----|
| 46 | Smart - Counter Measure Dispensing System (CMDS) | 68 |
| 47 | Adaptive Intelligent Front Towing Solution for Artillery Gun | 69 |

→ Logistics & Supply Chain management

- | | | |
|----|-----------------------------------|----|
| 48 | PRO-HM+ (AI-in SCM and Logistics) | 71 |
|----|-----------------------------------|----|

→ Manufacturing and Maintenance

- | | | |
|----|---|----|
| 49 | Artificial Intelligence Based Predictive Maintenance Suite | 73 |
| 50 | Predictive Maintenance for Gun Fire Control Systems | 74 |
| 51 | AI Based Predictive Maintenance of Delhi Metro Rail Equipment | 75 |
| 52 | Alloy Development through Artificial Intelligence | 76 |
| 53 | Predictive Maintenance of Mining Equipment Through Data Analytics and Telematics Enabled System | 77 |
| 54 | Condition Monitoring System for Shipboard Equipment (Main Engine) | 78 |
| 55 | AI-Enabled Evaluation of Welding Defects in X-rays of NDT | 79 |

INDEX



Operational Data Analytics

56	AI-Enabled Fake News Detector as Part of Social Media Analytics	81
57	Operational Data Analytics for Naval Platform	82
58	AI Enabled Automatic Information Extraction and Synthesis	83



Perimeter Security Systems

59	Sarvatra Pehchaan – AI Based Intrusion Detection & Integrated Command Station	85
60	AI-Enabled Forensic Search for Videos	86
61	AI-Enabled Gesture Recognition	87
62	Audio Doppler Based Object Classification	88



Process Flow Automation for Large Systems

63	AI-Based Automation of Water Sprinkling System	90
64	AI-Based Lighting Control system on HEMM (Heavy Earth Moving Machinery)	92

65	AI-Enabled Weld Inspection Machine with Computerized Radiography-(AI-RT)	94
66	AI-Enabled Weld Inspection Machine with Advanced Phased Array Ultrasound Technique-(AI-UT)	95
67	AI-Based Automated Bore Cleaning	96
68	Brainbox	97



Simulators / Test Equipments

69	Development of Artificial Intelligence-based training modules for technicians for operation and maintenance of SU – 30 MKI aircraft	100
----	---	-----



Speech / Voice Analysis Systems using Natural Language Processing

70	AI-Based Mandarin Translators	102
71	AI-Based Offline Language Translator	103
72	Speech-to-Speech Translation	104
73	AI-Enabled Voice Transcription Software	105
74	Voice Activated Command System (VACS)	106
75	AI-Powered Language Translation Platform	107



AI-Platform Automation

1. Deepcatch Edge AI Platform

Deepcatch is an Edge AI vision platform. It helps in monitoring of machines with alerts and notifications. Deepcatch also helps with remote diagnostics such as system troubleshooting, online system modifications, over-the-air upgrades and backup management.

Unique features:

- Capability to connect upto 6 POE cameras
- Improved accuracy, efficiency, and economic benefits
- Reduced human intervention
- Drive digital transformation at grassroot level
- NVIDIA® Jetson™ or NVIDIA® Xavier NX embedded
- Linux OS with board support package (BSP)
- Supports AI deep learning models
- Next Generation Edge AI Vision Platform which can be used for defence applications such as Drone detection, Intrusion Detection, etc.

Benefits: Monitoring:

- Machine Monitoring
- Alerts & Notifications
- Operator View
- Live Camera Feed

Remote Diagnostics:

- System Troubleshooting
- Online System Modifications
- Over-the-Air System Upgrades
- Backup Management

Analytics:

- KPI Reporting
- Preventive Maintenance
- Custom Dashboard
- Custom Reports



2. Merlin MLOps

Merlin is a MLOps solution for deep learning development, training and deployment. It eases the development and deployment cycle for deep learning by providing a simple means to create, edit, and deploy ML Models.

It helps to run experiments, predictions, view results on-cloud or on-premises, compute and deploy it on any supported smart device. It is possible to manage the entire MLOps lifecycle within Merlin.

Unique features:

- Useful for both experts and AI enthusiasts
- Features ready-made templates and work flows
- Annotate image, text and signal data
- Powerful, flexible, and scalable platform to build machine learning models.

Capabilities:

- Manage the Deep learning development lifecycle
- Use the guided workflows to help beginners in choosing the right models, parameters best suited for their specific type of problems and run experiments with just a few clicks.
- Annotate image, text and signal data
- Version your Machine learning artifacts like source code
- Run your experiments on the cloud or appropriate compute and update the model and weights on any supported device (smart camera, intelligent gateway, server etc) for production use.
- Merlin is a ML Ops solution for Deep learning development, training and deployment for all confidential military & defence applications.

3. iSentinel - Intelligent Automated Threat Tracking and Identification System

The threat from terrorists real and hybrid is an ever-present danger. There is a need to track and trace terror movements in real time. This helps in storing data that is useful to identify and build evidence on the network. Further, potential threats need to be flagged in advance and alerts need to be built in.

iSentinel is a deep learning-based threat detection and tracking system. Compared to ML systems, it has advanced learning algorithms.

iSentinel is capabilities:

- Real-time monitoring of people
- Real-time people counter and density monitoring
- Tracking of anomaly health indicators of people e.g. severe fever indicators
- Seamless Tracking of “People of Interest” across cameras and zones
- Automated behaviour analysis of people near “No entry” zones and sensitive zones
- Historical tracking of people
- Optional anonymous support
- Behaviour analytics for threat detection
- Integration with threat/security agencies databases
- Very effective solution for safety and security of high value assets, both defence as well as civilian in areas where terrorist / LWE threat exists.

Unique Features:

- Auto analysis and extraction of actionable information from video feeds
- Intelligent identification and tracking across multiple cams
- Software based multiple object-tracking
- Integration with IPS(Indoor Positioning System) to identify location of objects
- Software based image stabilization and feature/identity extraction
- Extensible detection to humans or non-humans
- Video summary to reduce archiving
- Forensics

3FRAMES



Detects Emotions, Facial Expressions and Body language for patterns of Argument, Restlessness/ Fidgetting and Sweating

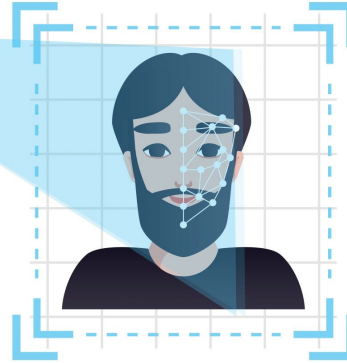

3FRAMES



Detects Emotions, Facial Expressions and Body language for patterns of Argument, Restlessness/ Fidgetting and Sweating using Facial Recognition and Behaviourial Analysis for anomaly detection.



4. System of Disseminated Parallel Control Computing in Real Time (DPCC)

Using AI to increase overall efficiency, the System of Disseminated Parallel Control Computing in Real Time uses plurality of processing units to perform parallel processing thereby eliminating time delays and reducing risks. As opposed to Monolithic architecture like mobiles that have delayed control leading to a crash due to system hanging; DPCC embedded architecture allows Direct Critical control communicated to Actuator at High speed for immediate action.

Features:

- Input from IMU to stabilize free body like vehicle
- Sensor fusion to create IMU & INS
- Corrections to Motors to Counter Roll
- Command to Table Right Turn
- Eliminates time delays
- Direct Critical control



Benefits:

- 10x increase in throughput
- 25x increase in output correction frequency

Applications of Technology:

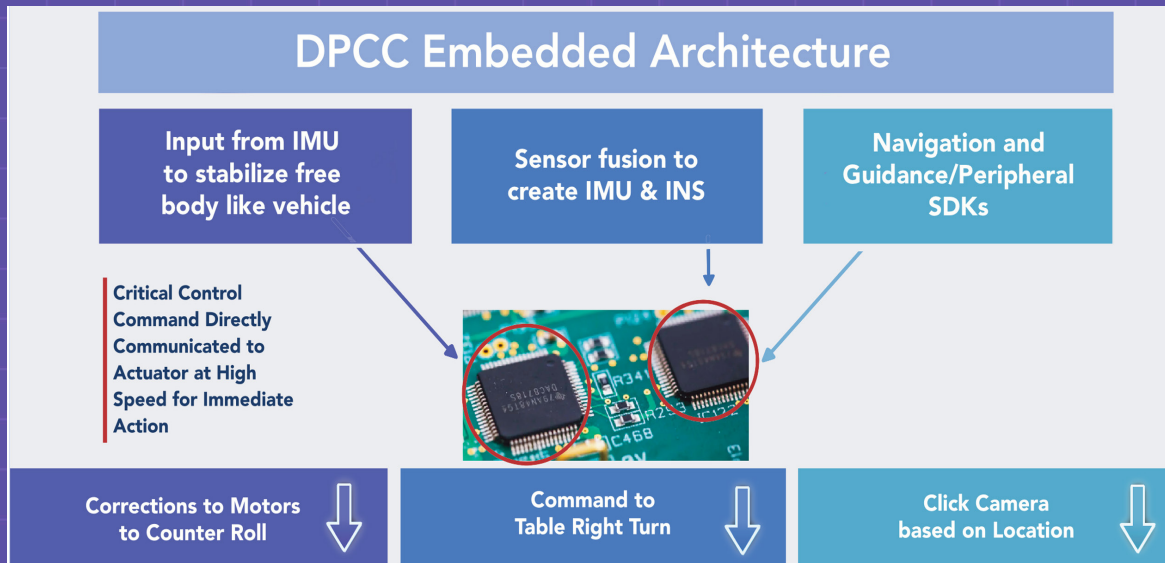
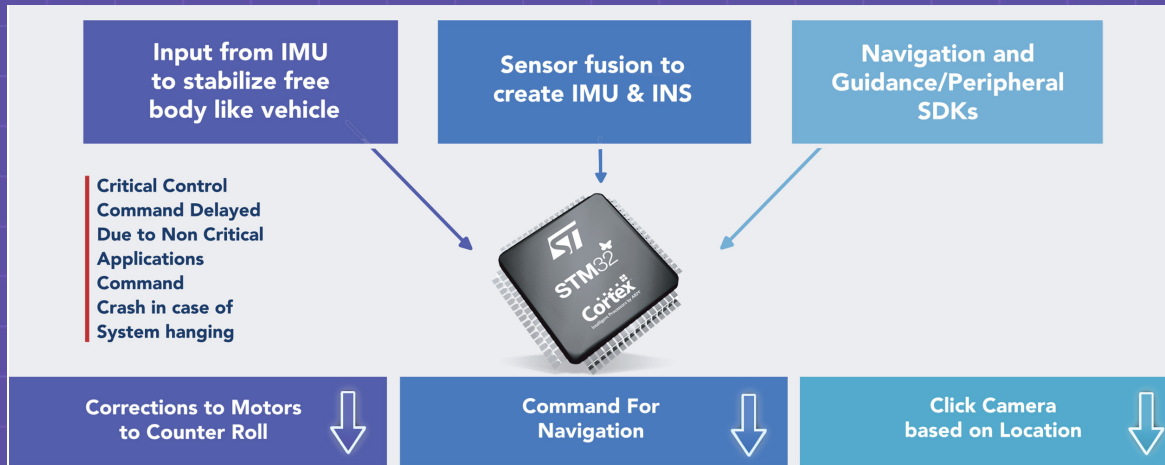
- ZUPPA NavGati Autopilot: Replaces Man to enable Unmanned Electronic Control Systems with DPCC useful for UAV, UGV & USV
- ZUPPA Drishti: Image processing made more efficient with DPCC used in See Through Armour (STA), Vision based Radar and ADAS
- ZUPPA Edge: DPCC enabled Geo located Data Acquisition & Transmission from sensors applied in Industrial IoT, Asset tracking and Connected mobility
- DPCC has been used for development across a range of defence products like See Thru Armour (STA) , loitering munitions, heavy lift UAVs , UGVs , Vision based Anti Drone systems, COTS Drones to replace Chinese DJI drones currently in use at the Unit level.





Autonomous / Unmanned/ Robotic Systems

5. Sapper Scout – Mine Detection UGV

The “Sapper Scout” is a mine detection UGV capable of detecting mines and marking mines using an illuminating spray. The UGV has a tracked platform enabling it to move cross-country on all kinds of terrain. The prototype also consists of a 5-axis robotic arm for cutting the trip wires of fragmentation mines. The UGV has 3 different cameras – one for accessing the detected mine, the second for mobility of the UGV and the third is for 360-degree recce of the environment.

Mine field breaching has traditionally relied on manual practices, procedures and drills, which are slow and labour intensive.

In the Indian Army, the existing system that is being used to carry out mine field breaching, is that of trawl tanks. These trawl tanks move in tandem into the mine fields and blast the mines when the rollers travel over them. These tanks are redundant over anti-tank mines. There is a lot of delay and efforts in replacing such trawl tanks which are damaged by such mines during breaching.

Salient Features.

- (i) Mine Detection
- (ii) IED Detection
- (iii) Long Range Surveillance
- (iv) Metal Detection
- (v) Minefield Marking



6. AI Capability in Swarm Drones

Drone Swarms are a group of drones operating in conjunction with ground manoeuvre forces. This provides an aerial manoeuvre capability during offensive as well as defensive tasks. The shaping of the battlefield can be greatly influenced by Drone Swarms, thereby allowing preservation of decisive columns of mechanised forces initially and the application of such forces at a place and time of choice.

The inherent advantages of affordability, flexible employability, redundancy, precision, software domination, reduction in mission costs, Beyond Visual Line of Sight (BVLOS) attack capabilities and risk of human casualties make the Swarm Drone a potent weapon for conventional as well as non-conventional operations.

Swarm Drones can be effectively employed to detect enemy ground activities and target enemy ground forces to include troops, vehicles and command and control links.

Artificial Intelligence and machine learning algorithms used in the system are capable of communicating with each other to form a swarm and achieve a collective goal. Artificial Intelligence algorithms have also been designed and developed to

compute the shortest path, form a pattern and achieve a common goal such as the combined search of a large area. Each drone is powered with distributed active collision avoidance algorithms. These algorithms compute any future collision with every other drone and alter its path dynamically.

Target Detection & Identification.

Target detection and identification algorithms used in the system enable detection and identification of small-sized targets, vehicles and structures from a high altitude and over a large distance. These algorithms are able to perform precise identification, wherein it is able to distinguish between equipment, humans, animals and other objects. Depending upon whether the target is a friend or foe, it also suggests action that can be taken to neutralise the threat if any, to the operator.



7. Project Drone Feed Analysis – AI based RPA feed and data analysis

Drone Feed Analysis system is an AI Deep Learning-Based real time/post flight military object identification system. It identifies military objects from remotely piloted aircrafts (Searcher, Heron, etc.)/quadcopter feeds. It builds a database repository and carries out AI-enabled analysis providing military pattern of enemy operations and analysis/prediction of events.

Applications:

Conventional military Intelligence Surveillance Target Acquisition & Reconnaissance (ISTAR) Missions, Smartization of Road Opening Party (ROP) Ops, Live Monitoring of counter terrorism operation, Border Surveillance, Illegal Immigration Movement, Drugs Trafficking, Disaster Response, Progress Monitoring (Traffic, Agriculture, Shipping & Construction etc).

Unique Features:

- Cutting-edge security layer to protect classified Data
- Indigenously designed and developed
- Localised high-speed processing
- State-of-the-art AI computer vision algorithm
- Predictive and prescriptive analytics
- Look-back analysis and geo tagging
- Platform for sharing strategic surveillance information amongst RPA operating nations

How it will Serve the Nation:

- Exponentially efficient and effective use of strategic surveillance assets
- Reduces the operations engagement time
- Technology driven operations
- Aids in situational awareness and informed decision making
- Increases the area under surveillance
- Drastically reduces cost of surveillance missions and analysis

Export Potential Countries -

Countries using Searcher and Heron and similar RPAs.

• Asia & Pacific

Vietnam, Myanmar, Turkey, Philippines, Thailand, Malaysia, Indonesia, Sri Lanka, Israel, Saudi Arabia, UAE, Qatar, Kuwait, Oman, Bangladesh, Nepal, Bhutan, Japan, Australia, New Zealand

• Latin America & Africa

Mexico, Chile, Venezuela, Colombia, Brazil, Argentina, Kenya, Nigeria, Botswana, Egypt, DRC, Cameroon, Sudan, South Africa

• Europe

Germany, Belgium, Austria, Ukraine, Poland, France, Italy, Czech Republic, Finland, Sweden, Greece, Russia



Range:
0 km - 3 km



OBJECTS IDENTIFIED

- 1) OHP and
COMM TRENCH

NEXT ACTIONS

- 1) DF BUNKERS
- 2) FL AMMO BUNKER
- 3) COY HQ
- 4) OP



Range:
10 km - 50 km



OBJECTS IDENTIFIED

- 1) GUN POSITIONS

NEXT ACTIONS

8. Silent Sentry (Rail Mounted Robot with AI)

AI-based surveillance robots are being developed by countries like South Korea and Israel for manning of the border fences. There is a need to utilise robots and AI for covering gaps on AIOS as well as perimeters of units and installations so as to create deterrence and enhance the surveillance grid.

Silent Sentry, the fully 3D-printed rail mounted robot slides on a rail that can be installed on fences and AIOS. The robot can be controlled from computers/tablets and android app as well as function autonomously within set limits.

Robot Details:

(a) **Motion** The robot traverses on metal rails between two setpoints and utilises an electric motor for propulsion.

(b) **Communication Network** The robot communicates by creating an ad-hoc network running on 2.4Ghz Wi-Fi standards. Two wireless routers are installed on the endpoints on the rail that provide wireless coverage to the robot. The routers are then connected by LAN cables or wirelessly with the computer where video processing is carried out.

(c) **Optical Sensor** Standard COTS available wireless IR surveillance camera has presently been installed on the robot. The camera has a 95-degree horizontal field of view and detection range of 30m in night and is similar to those utilised for perimeter surveillance by units. Any wireless camera system can be added to the robot.

(d) **Artificial Intelligence** The system utilises two AI features for surveillance i.e. Human Detection and Face Recognition for the purpose of surveillance. The details are as follows:-

(i) **Human Detection** The video feed received from the robot is analysed by an AI software utilising object recognition. The software detects movement and human presence automatically, generates an audio alarm and stores the photographs with time and date log.

(ii) **Facial Recognition** On detection of a human, a background facial recognition algorithm is activated, which tries to determine the identity of a person from stored database. The facial features are then stored in the database.

(e) **Automatic Charging System** Robot can traverse 300 meters multiple times on battery for 4 hours. A low battery current and voltage sensor sends the signal to the robot and generates an alert. On sensing the low voltage, the robot automatically moves to the charging station and docks with the charger till the batteries are fully charged.

(f) **Software Control** Multiple modes of operation

have been provided for control of the robot on the user interface. Users can select manual mode, automatic patrolling mode, switch off/on facial recognition, human detection and audio alarms as per customised requirements.

Salient Features:

- (a) AI based Object Detection.
- (b) Wireless Control and Telemetry.
- (c) Autonomous and full time Patrolling
- (d) 3D Printed.

Uniqueness.

- (a) AI-based robot with automatic intrusion detection.
- (b) Autonomous Patrolling Mode.
- (c) Automatic battery level sensing and charging.
- (d) Audio/Video Alert Generation.
- (e) Robotic Swarm Capabilities.
- (f) Wireless Functioning.
- (g) Can be integrated on existing AIOS.
- (h) Face Recognition Capability.
- (i) Integrated AI, Robotics and Internet of Things.

How is it going to serve the Nation?

- (a) Enhance deterrence by deployment of AI Robot for patrolling on LC for domination, anti-infiltration mode and perimeter protection
- (b) Automatic intrusion detection automates intrusion detection leading to better security
- (c) Integration of AI, Internet of Things and Robotics will lead to better exploitation of existing technology
- (d) The robot acts as a first responder in case of emergency and thus leads to better situational awareness

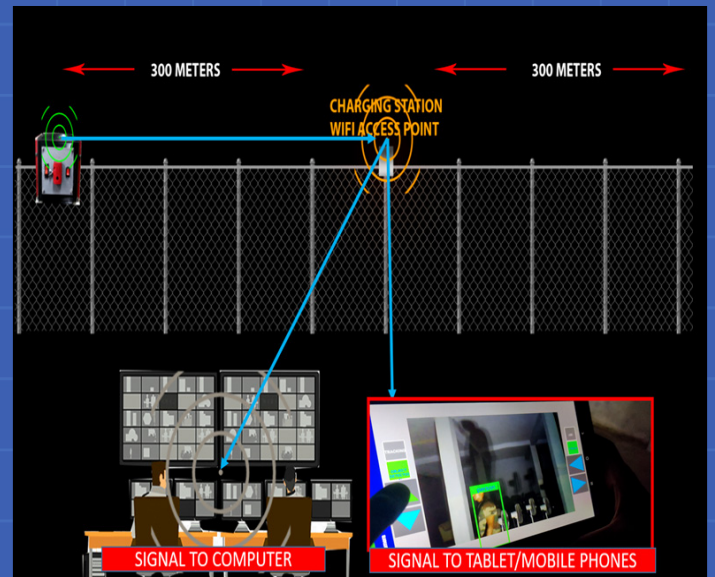

9. Autonomous Fast Intercept Boat (AFIB)

The AFIB is an indigenously developed platform in collaboration with BEL with advanced software & algorithms to have capability to perform autonomous operations up to 25NM speed range. The AFIB is an AI-based flagship product in the marine segment and first of its kind in India. The vessel is capable of performing its autonomous operations even in dense maritime traffic and in shallow water areas.

The AFIB is fitted with navigational sensors like high resolution HR/IR camera, high end X band Radar, Lidar, 200 KHz Chirp based Eco-sounder, Maritime HCRR communication set having range of 30 kms, Onboard PC with Software suite for AFIB navigation etc.

The above equipment makes the AFIB unique in nature to perform the autonomous operations in various modes as described below:

- Remote Controlled Mode – User can Navigate the boat using wireless remote control unit using inputs of Camera, Lidar & real time location on map.
- Way Point Navigation Mode – User can set way point as per needs of operation. No Human interface required in view of dynamic collision avoidance algorithms
- Autonomous USV Mode – User can autonomously operate the boat defining the mission

Expediency of AFIB (How will it serve the Nation):

The AFIB can perform a range of operations and few of them are mentioned below:

- Autonomous operations for search & rescue operations
- Autonomous operations for Special Forces
- Autonomous operations of Patrolling & surveillance in dense maritime traffic
- Interception & Boarding of High-speed vessels
- Flood Rescue Operations
- Hydrographic survey operations with appropriate sensors.

10. Project Storm Drone (Automated Room Intervention Drone)

The AI-enabled automated room intervention drone systems with lethal and non-lethal payload are used to carry out building clearance and urban surveillance in GPS denied areas.

The applications vary and include counter-terrorism room intervention operations, urban area surveillance, disaster response, rescue operations in underground mines (coal & iron mines), construction, forest, and poaching monitoring.

The system could be expanded to NSG, Marcos, Garud, STF, police, paramilitary forces, disaster management, and the forest department.

Unique Features:

- Indigenously designed, developed, and deployed
- Works in GPS-denied environment
- Autonomous navigation
- Collision avoidance
- Ability to deliver lethal and nonlethal payload in urban operations

How it will Serve the Nation:

- Saves lives of military and civilians in urban counter terrorist operations
- Reduces the engagement time in operations
- Technology-driven operation
- Aids In situational awareness and informed decision making
- Urban surveillance and tracking of threats

Export Potential Countries - Countries Engaged in Counter Terrorism & Urban Combat Missions

• Asian Countries

Iraq, Syria, Myanmar, Philippines, Yemen, Thailand, Turkey, Indonesia, Sri Lanka, Iran, Israel, Palestine, Bangladesh, Lebanon, Afghanistan, Saudi Arabia, South Korea, Japan

• Europe

France, Germany, Spain, Belgium, Norway, Greece, Ukraine, UK, Russia

• North, South America & Pacific

United States, Canada, Mexico, Chile, Colombia, Chile, Australia, New Zealand

• Africa

Nigeria, Cameroon, Egypt, Democratic Republic of the Congo, Mozambique, Chad, Kenya, Libya, Algeria

1. Lead Room/House Intervention Ops
2. Urban Surveillance
3. Lethal/Non-lethal Pay Load
4. GPS Denied AI Navigation



CRASH RESISTANT - Carbon fiber body & collapsible rotor blades



PAYLOAD – 650g
(HE/Smoke/Flashbang/Chilly/IED)



VIDEO OUTPUT RANGE
– 600 Meters

OPS WITH ASSAULT DOG



HOUSE CLEARING OPERATIONS IN MULTI FLOOR BUILDING WITH DISPLAY FEED

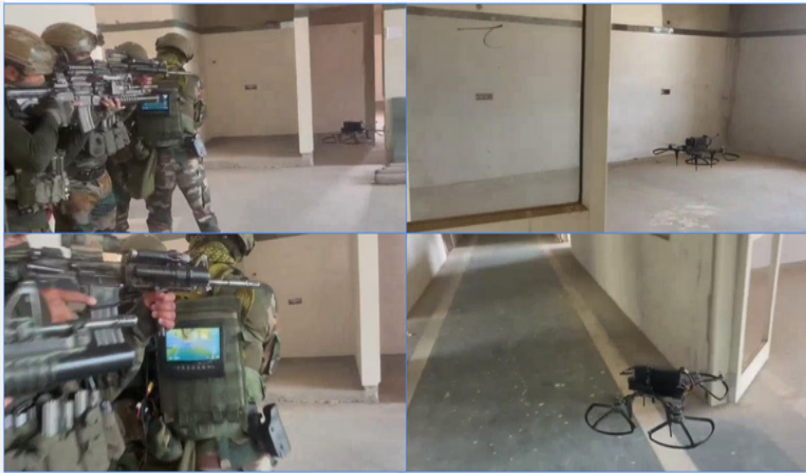

MULTI DISPLAY FEEDS



11. Cognitive Radar

Present modern radars face challenges in the requirements of robust detection mechanism in the dynamic environment even though Phased Array Multi Beam Radar Architecture has the capability to provide multi dimension information.

DRDO Young Scientist Laboratory – CognitiveTechnologies – has addressed certain issues through use of Deep Neural Network andReinforcement Learning methods in the areas of Target Detection, Angular Estimation, andWaveform Adaptation.

The project implied complete development of hardware and a set of advanced AI algorithms.

Unique features:

1. Convolutional Neural Networks-based target detection
2. Signal-Noise Ratio improvement using range migration and Doppler compensation
3. Efficient ambiguity resolution algorithm for Doppler deduction
4. Angular estimation
5. Target classification using range profiling
6. Waveform adaptation at transmitter
7. Filter for ballistic missiles (boost and ballistic phases)

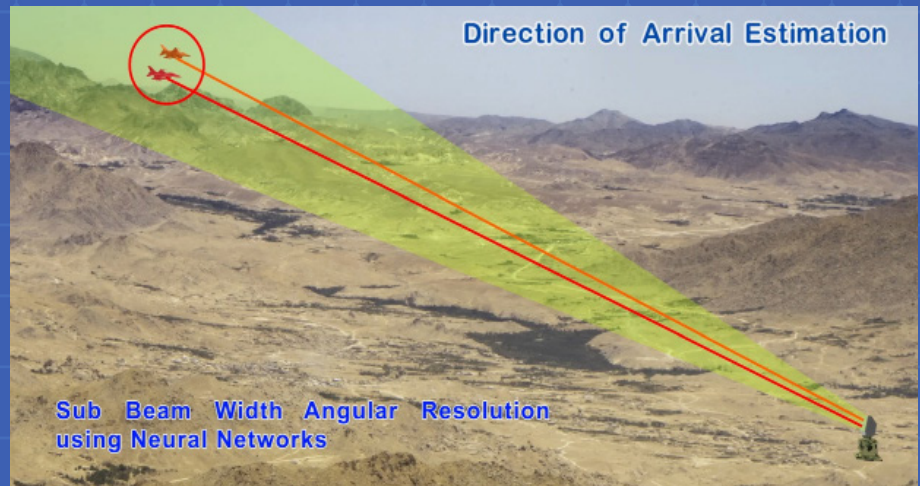
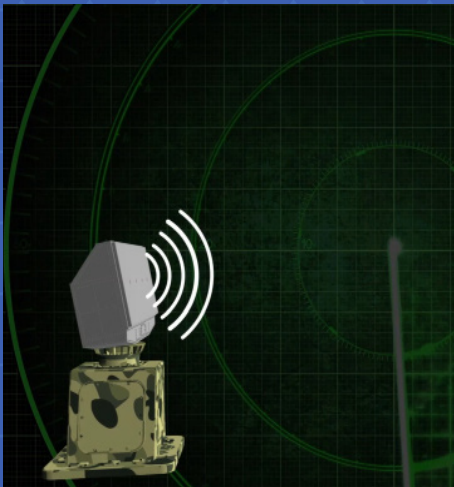

12. AI-Enabled Remotely Operated Vehicle (ROV)

An AI-enabled ROV has been developed for underwater inspections of marine/civil infrastructure with advanced capabilities for feature recognition. Multiple sensors including vision-based tools, are employed in the ROV and data is readily available in a digital format for the use of software image-enhancing toolsets and AI algorithms.

ROVs can access narrow and dangerous areas of concern, increase the speed of underwater inspection in the field and improving productivity. Thus making them ideal inspection tools

Unique features:

- Advanced control system for easy operation
- Maximum depth rating: 50 m
- Modern optical and sonar-based survey
- Hydrodynamic open frame design
- Assisted obstacle avoidance
- High thrust and manoeuvrability
- High-definition, real-time visual system
- Ultrasonic thickness measurement
- Deployable up to sea state 3

SALIENT FEATURES:

- Dimensions: 0.9 m x 0.9 m x 0.9 m
- 2 Nos of digital camera with video specification FHD (1080p - 30 FPS)
- Mechanical scanning sonar
- AI enabled vision software
- The ROV can be used for inspection of ships, platforms and marine infrastructure

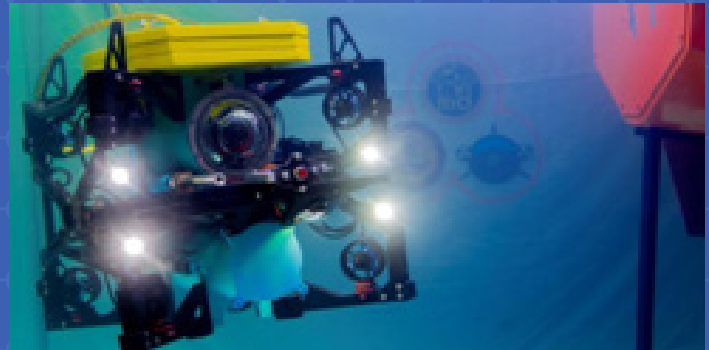

13. HR Chatbot 'Anvesha'

This AI-enabled Chatbot is a process improvement initiative and has helped the Digitalization of Employee services by providing information directly in their mobile phones and as a next level of service, further improvement to integrate SAP HRMS is being carried out.

Unique Features

This Chatbot has enabled employees to download Personal documents, answer to the FAQs on HR policies & rules, providing a glimpse of latest happenings in GRSE for awareness on company development & enabling viewing of latest circulars and notices, etc.

Cost of Development

15 Lakhs

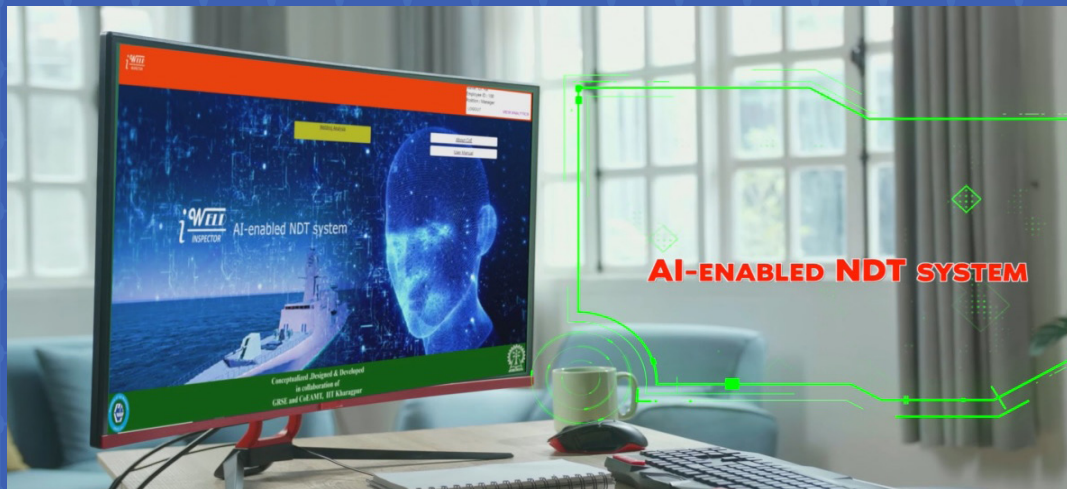

Developed by Garden Reach Shipbuilders & Engineers (GRSE)

14. AI-Powered Unmanned Ground Vehicle

ECARS UGV is a multipurpose, multi-terrain modular platform. The perception and navigation modules are AI-powered which enhance the capability of vehicle to traverse across multiterrains and being modular as per application demand for implementing full unmanned control and safe functionality of platform. This enables our forces to take on the critical missions and circumvent casualties.





Block Chain Based Automation

15. Permissive Block Chain Mechanism

The solution is intended to create a Trusted Communication Platform using Block chain. The idea is to establish a secured network for data transfers between DPSUs. Distributed Ledger is the concept used for development with necessary Identity management and control mechanism to protect the data shared among different organisations. The proposed use-case solution is planned to provide transparency, security and auditability for file sharing among DPSUs using Block chain Technology.

Application of Products

- AI to be used for traffic pattern analysis for the security purpose of the entire system.
- The BCIDM (Block chain based Identity Management) solution is useful to Defense forces to collaborate and share information amongst, after verification of their identities.

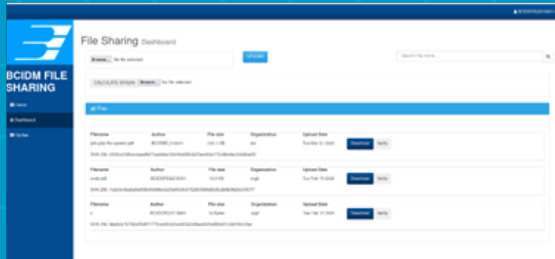



**Command, Control, Communications,
Computer and Intelligence, Surveillance and
Reconnaissance Systems (C4ISR) Systems**



16. AI-Based Intercept Management System (IMS)

Requirement.

One of the major tasks in EW Operations is corroboration of intelligence that requires analysis and interpretation of huge number of intercepts or generation of Common Operating Intelligence Picture (COP). The analysis, visualization and interpretation of such unstructured data is a challenging task. Further the predictive analysis of future operation events requires the support of Artificial Intelligence to plug the gaps. Hence, an urgent requirement was felt to design and develop Artificial Intelligence Based Intercept Management System.

Brief Description.

IMS is indigenous software developed in house to analyse and automate intercepts of adversary in Western Theatre. The software makes use of visualization techniques and artificial intelligence to interpret op-critical data thereby generating accurate intelligence picture.

Salient Features.

- (a) Identification and classification of operationally critical EW intercepts.
- (b) Automated analysis and interpretation using artificial intelligence.
- (c) Categorization and visualization of intercepts using data science tools.
- (d) Creation, corroboration and migration of threat library.
- (e) Records of audio intercepts to ensure integrity.
- (f) Generation of Common Intelligence Picture of adversary based on probabilistic and deterministic approach.

17. AI-Based Motion Detection & Target Identification System in LC

Surveillance inputs of all EO/IO are in the form of real-time video feeds converging at the company posts/ Battalion Surveillance Centre/ Divisional Surveillance Centre etc. Manual monitoring of real-time continuous video surveillance is very cumbersome and monotonous in nature. At present, no system exists in the Indian Army which can automatically detect and classify objects for target identification.

Proactive Real-time Intelligence and Surveillance Monitoring System (PRISM) is an artificial intelligence based system which is the first-of-its-kind software in the Indian Army, capable of generating real-time audio/ visual alerts on

detecting suspicious enemy movements from multiple surveillance inputs like PTZ Cameras, LORROS, HHTI, TTIOE etc. employed for monitoring real-time feeds from line of control, line of actual control and counter insurgency/ counter terrorism areas to perform real-time motion detection, target identification and tracking.

Salient Features:

- Real-Time Video Analysis
- Multi Class Object Detection
- Multi Point Camera Integration
- Night Capable Using IR & Thermal Vision
- Audio Alarm & Alert System

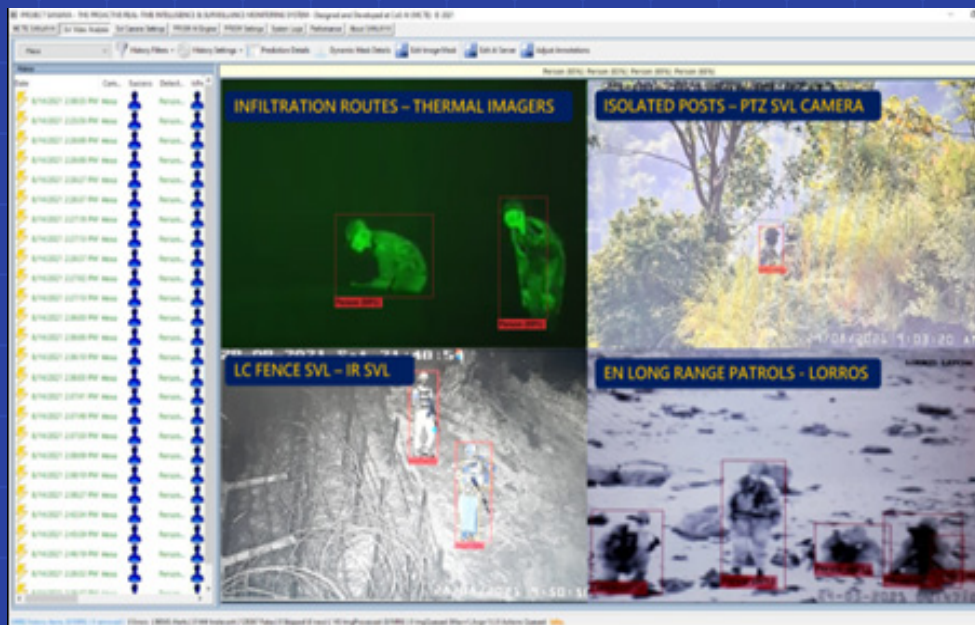

18. Continuously Observing Ubiquitously Available AI-Surveillance System

Existing surveillance equipment deployed for early warning of enemy intrusion, suffers from inherent disadvantages of line-of-sight limitations with deployment restricted to own side. It is resources heavy, with a high power requirement and the need for continuous manning.

To obviate these restrictions, there was a need to develop a small portable surveillance system, which would be capable of processing images, extract relevant data and transfer the same to any control centre/ surveillance centre in the hinterland.

Choukass is designed to bring a host of benefits to AI-based surveillance:

- Designed to obtain early warning of any intrusions
- Extremely portable
- Optical sensor constantly monitors the field of view
- The information is transmitted real time through a small in-built NB-IOT satellite module to a customised web portal accessible at own surveillance centres.
- Designed for sustained operations (high density li-ion based solar generator)
- Camouflaged pattern, minuscule cross section and ubiquitous nature of connectivity enables it to be deployed in all kinds of terrains

Features:

- Artificial Intelligence enabled and globally deployable.
- Data of enemy movement accessible at own surveillance centres/ decision makers in real time.
- No cable infrastructure required.
- High endurance, 200W inbuilt solar generator with foldable 50W solar panel for continuous operation with a power consumption of maximum 15W.



19. AI-Enabled Airborne Electro-Optic Infrared System

DRDO's state-of-the-art AI-based object detection and classification system is based on advanced AI algorithms and helps many agencies including the armed forces when it comes to border surveillance and monitoring suspicious personnel and vehicular movement.

Unique Features:

- State-of-the-art Artificial Intelligence Algorithms
- Convolutional neural network-based Object detection
- AI-based Object Classification and Tracking
- Deep network-based Fusion of Day and Thermal Camera
- CNN and Farneback based Video Tracking

Applications

- Multi-mode maritime surveillance for ships, cruisers, tankers etc.
- Integrated coastal surveillance for objects of interests such as boats, trawlers etc.
- Border surveillance for various agencies for monitoring suspicious personnel and vehicular movement.
- Can be used in belly up / down position of the aircraft making it suitable for aerial
- surveillance of an area of interest.
- Ideal surveillance equipment for tracking of objects of interest such as vehicles, personnel or flying object for the police forces.

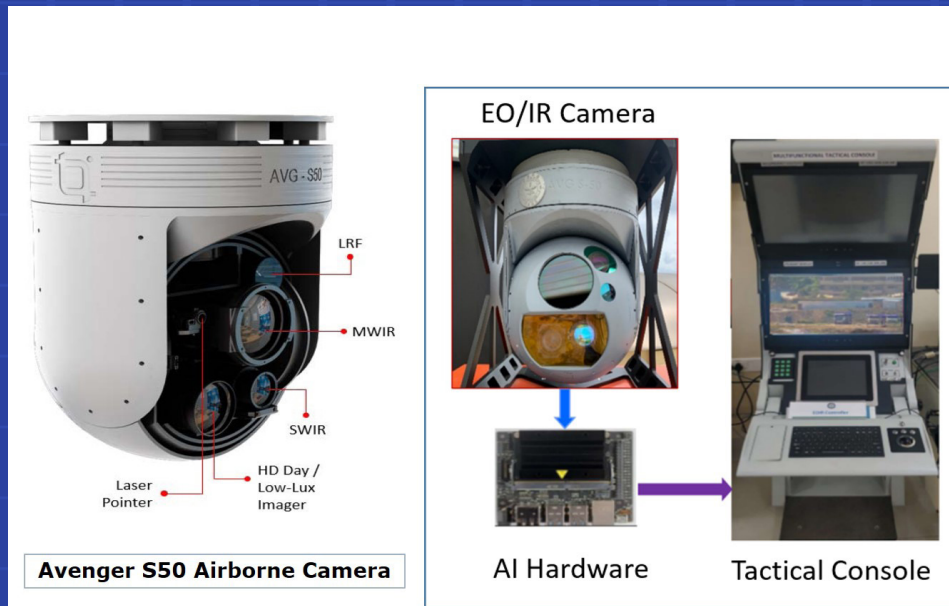

20. Deep Learning Toolkit for Aerospace and Defence

One of the most powerful and compelling types of AI is computer vision. This deep learning toolkit is capable of computer vision, NLP, reinforcement learning, sensor processing, tracking and fusion and a general adversarial network.

Unique Features:

AI-based Automatic Target Recognition involving

- ATR in Airborne Camera
- SAR ATR
- EO/IR Image/Video Fusion
- Oil Spill Segmentation

AI-based Sensor Processing involving

- IFF Mode Code Detection
- Target Detection from RD Map
- Tracking of Radar/IFF Measurements
- Sensor Data Fusion

- AI-based audio transcription and translation
- War-gaming Simulation using RL
- GAN-based Sketch-to-Image Synthesis
- Dual Domain Net-based Change Detection

Applications:

- Automatic Target Recognition
- Training of Pilots against intelligent adversary
- Validation of rule-based algorithms in various domains.
- Performance benchmarking against AI-based solutions.
- Range extension of surveillance sensors through AI-based signal processing.
- Online and offline Speech analysis of intercepted radio communication.

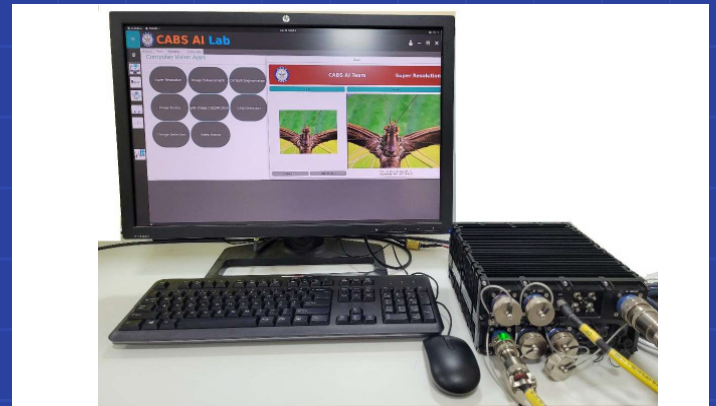

21. Adversary Network Analysis Tool (ANANT)

Law enforcement agencies need to understand and analyse data in two dimensions. Spatial and temporal data. Adversary Network Analysis Tool (ANANT) offers spatiotemporal analysis to analyse multi-mode and multi-relational adversary networks, which are the current and future requirements of State Police and other Law Enforcement Agencies (LEAs). This product satisfies the static and dynamic network analysis needs of most of the LEAs under one roof. Potential users of this solution are State and Central Intelligence Agencies, Law Enforcement Agencies and Defence Forces.

Innovative features:

- Identification of Crime patterns
- Hot Spot analysis based on Crime type and Location
- Criminal Tracking
- Geo-tagged Sentiment analysis
- Crime Insights generation
- Risk Terrain Mapping Techniques to Identify Crime Vulnerabilities etc.
- Employs modern Predictive Policing techniques that not only predicts crimes by identifying areas at increased risk, but also Predicting approximate Geo location

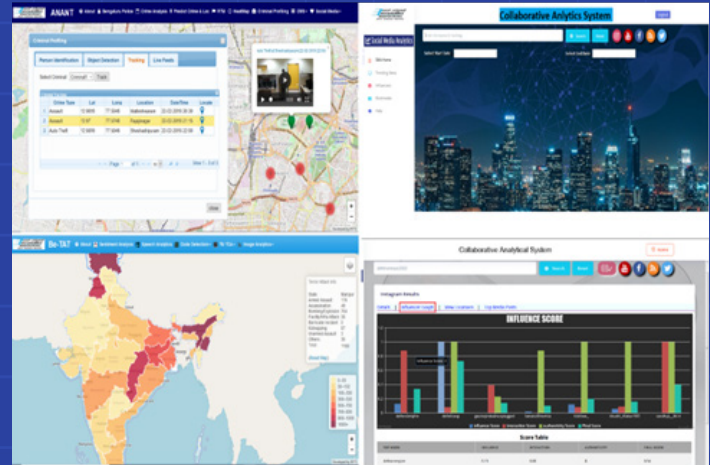

22. Target Tracking for Complex Naval Scenarios

Traditionally, tracking of the Naval targets is performed using the correlation technique. However, in this product, AI-based techniques are used for detecting Naval targets. The Naval target tracking is extremely complex as the targets get embedded in the background.

The system is useful in surveillance of naval targets for low range, mid-range and long-range applications. The position of the detected targets can be used for firing on the target.

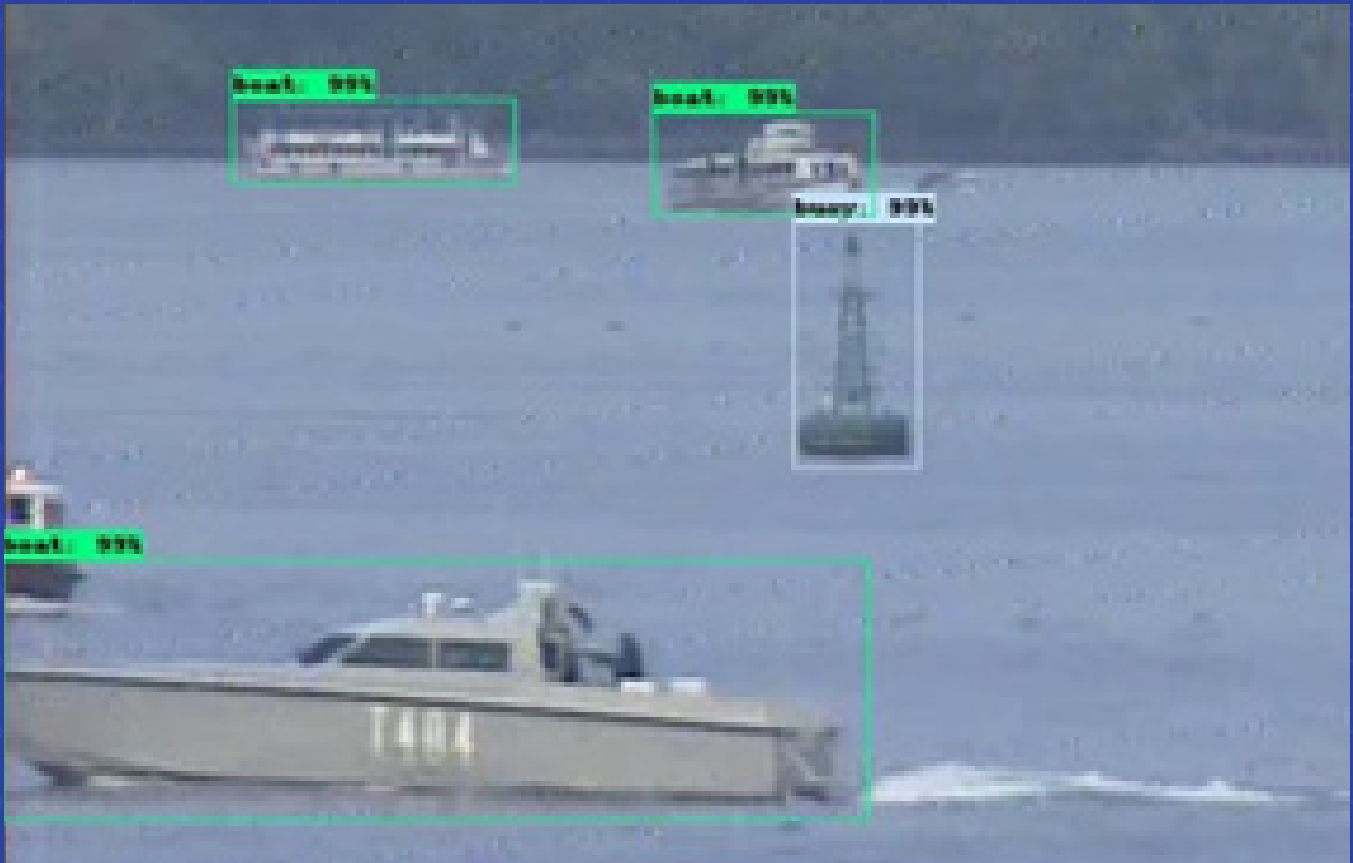

23. Animal Detection for Railways

AI can help tremendously in the preservation and safety of the wildlife when railway lines pass through their territory.

In the interest of wild animal safety and as an aid to the Railways, BEL has developed AI Model that detects wild animals like elephants, rhinos etc. from the video sequence and triggers an alarm to alert the train operator to take pre-cautionary measures. This solution helps in avoiding wild life-train collisions on railway tracks by generating alerts/alerts to the train operator. It

replaces the need for installing and maintaining fencing along the rail roads and reduces mortality due to accidents.



24. Enemy Aircraft Activity Recognition & Classification

AI can help identify enemy aircraft and even their plan of action. This makes it easier to take evasive action or launch an effective counter-attack.

In an air defence scenario there is a high probability that threats will emerge in single or multiple groups and formations from the different parts of general hostile areas. They may take part in different kinds of fringe or coordinated attacks. Timely recognition and identification of such coordinating groups or packages, their activities and trends in real time and recognition of the adversary's plan that is a possible enemy course of action, are immensely useful in any war or combat situation and particularly for air defence.

This solution has been developed using AI & Cognitive Computing techniques and is a first-of-its-kind in the country. This unique solution enables the users to automatically recognise and identify enemy aircraft's plan from the observed activities well in advance, leading to improved situational awareness and enable to undertake timely countermeasures according to the identified plans.

Currently this solution has been developed for Air

Defence System of the Nation and shall be implemented in IACCS. Further, this module could be utilised by other services e.g. Indian Navy, Indian Army for their air defence system to improve the situational awareness and response to any enemy intrusion into the air space.

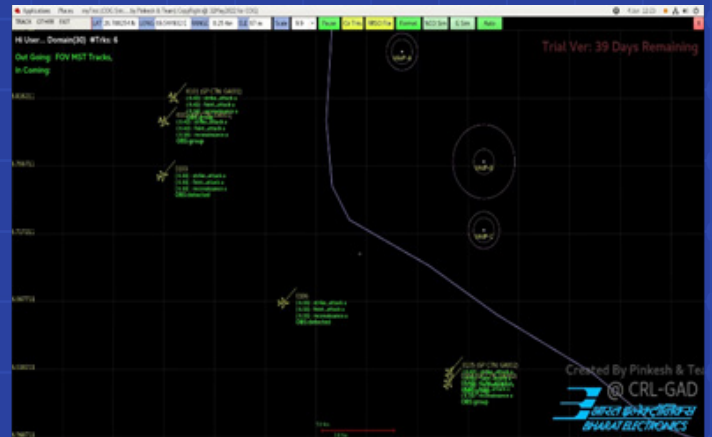

25. AI-Based Anomaly Detection for Maritime Domain

Maritime Motion Pattern Recognition & Anomaly Detection is a novel approach for motion pattern extraction and anomaly detection in maritime vessel traffic, based on circular quad trees.

The approach builds/learns a model of normal behaviour inside the circular region associated with each node of the quad tree based on kinematic parameters such as location, course and speed of a ship. Based on the learned model for normal vessel behaviour, the method detects three types of anomalies viz. standard route deviation, speed and course variation. Methods of statistical estimation of probability distribution are used for normalcy modelling of kinematic parameters at each node of the quad tree.

Maritime surveillance is an important aspect to the national security and safety. The Maritime Motion Pattern Recognition & Anomaly Detection is an integral part of Sangraha (Maritime Domain Awareness & Decision Support System) delivered by BEL after replacing the M/S Raytheon's Athena Software at Information Management & Analysis Centre (IMAC), Indian Navy. The advance decision support capabilities of Motion Pattern Recognition & Anomaly Detection are integrated with Chain of Static Sensors (CSS), Indian Coast Guard which currently in the deployment phase.



26. Passive Ranging using AI as a Classifier

The image range estimation system developed by BEL uses an artificial intelligence-based method to detect objects in the images and then uses pinhole camera geometry to estimate the range. It consists of 2 stages – object detection/tracking and range estimation. In the object detection/tracking stage, size and position of object in the captured image are determined. In the second step, range is estimated using the computed object size and real object size according to pinhole camera geometry. The system can estimate ranges of the object from a single image. Presently, the system works for vehicle and person detection and their range estimations.

Key Features:

- Works for a minimum object pixel size of 25*25
- Detects and estimates ranges for objects such as persons and vehicles
- Deep learning techniques are used for object classification
- Developed algorithm can be used in collision avoiding systems for vehicles in smart city applications

This solution is useful for smart city applications such as “Forward collision warning (FCW) system” that detects vehicles ahead and issues warnings to drivers for avoiding or mitigating the harm caused by crashes. It can also be used in robots and in drones for object distance estimation.



27. AI Based Passive TWS (Track While Scan) System

Artificial Intelligence (AI) refers to the simulation of human intelligence in machines that are programmed to think like humans and mimic their actions. AI plays an important role in homeland security applications like video surveillance, target tracking, image stitching in panoramic view, monitoring of activities around the borders for surveillance purposes, remote observation of important places and installations.

BEL has developed the PATWAR system for naval surveillance application mainly in the Defence sector where one can monitor objects of interest using a camera mounted on a Pan-Tilt Platform. The platform rotates the camera continuously which captures the images of the surrounding area being monitored. The PATWAR application generates a 360-degree panorama view of the surrounding area from the images received by the rotating camera and then it detects the objects of interest using deep learning.

The system provides a GUI where all the information like the generated panorama, live feed from the camera is displayed. It also provides a facility for the operator to see the zoomed-in version of the detected object by clicking inside the region provided around the detected object to get details of objects.

Salient Features

- Real time streaming of IP camera.
- 360-degree panorama view generation.
- AI-based object detection framework to detect objects of interest in 360-degree panoramic view.
- Graphical User Interface. (GUI)
- Full view of detected object.



28. Development of Machine Algorithms for Maritime Anomaly Detection

Deep Darshak(TM) is a machine learning/AI based platform for carrying out analytics on AIS and other ship position data to assist the users in identifying vessels of interest and suspicious activity. The system uses deep learning, python algorithms and the latest data processing techniques to ensure safety and security of our seas.

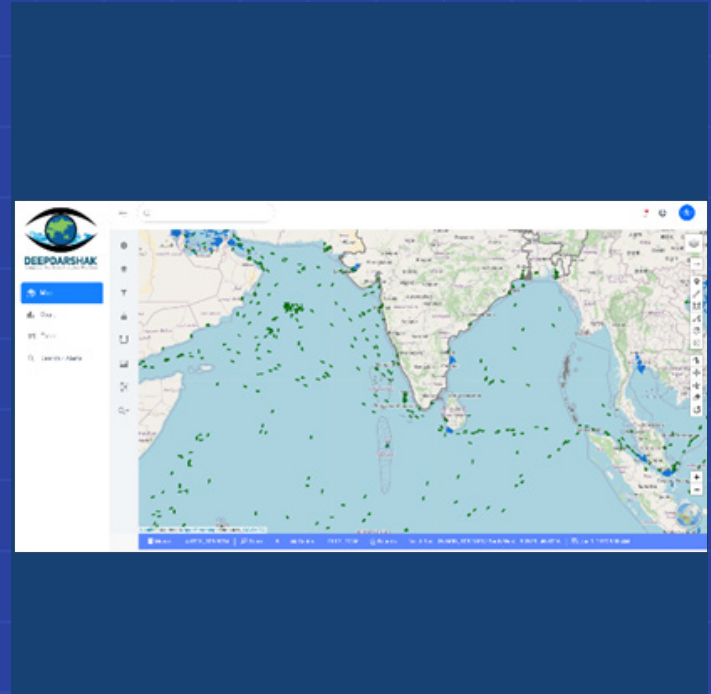
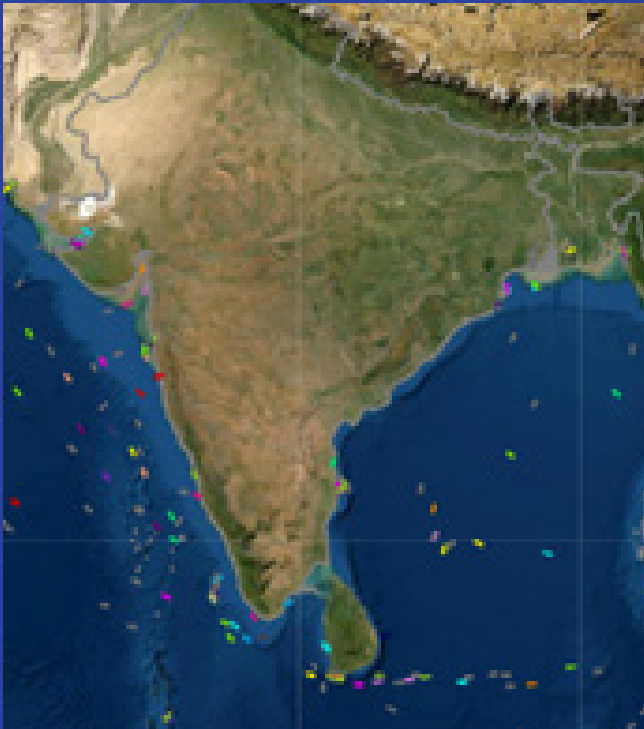

29. Enhancing UDA by use of AI/ML and other Novel Techniques

Underwater Domain Awareness (UDA) is challenging and requires processing voluminous data (primarily acoustic in nature) to discern objects / sounds of interest amidst the background noise.

Ambient noise cancellation and the use of better algorithms / signal processing can also increase the range of detection. Underwater sensing is a key to enhance UDA. An Acoustic Vector Sensor Array (AVSA) can triangulate individual measured bearings to provide sound source localisation, thereby helping to characterise sounds specific to a source.

By utilising an array of three vector sensors, the application of beamforming techniques can provide sound source localisation, allowing for characterisation of the acoustic signature of specific underwater acoustic sources. Data from each sensor is agglomerated into an AI-based software and will confirm presence of underwater targets in the area.

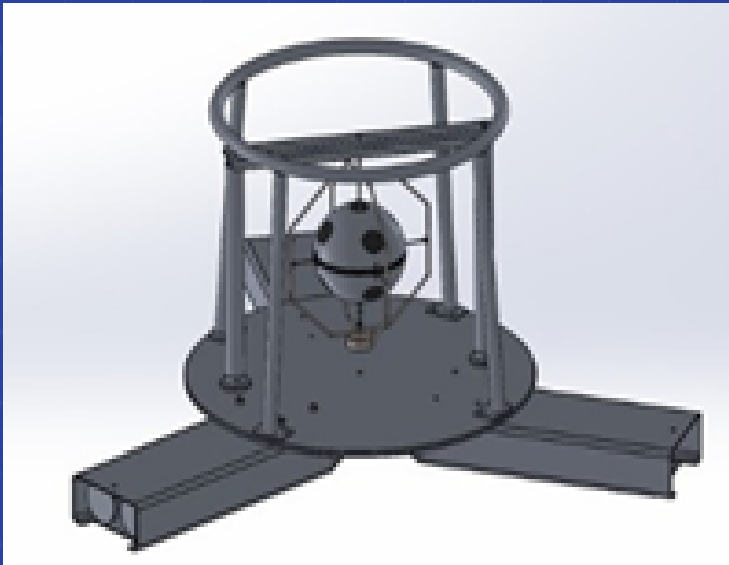

30. AI/Big Data for Acoustic and Magnetic Signature Analysis

Currently, all activities – measurement of data, processing of data, generation of graphs to the creation of reports – is a separate manual activity making data processing & final report generation time consuming and susceptible to human errors.

This AI-based system for signature analysis is a project for Indian Navy's Under Water Range (NUWR) at Goa. Proposed AI/Big Data solution will counter all the above issues.

1. Raw acoustic data captured by sensors
2. Broad and Narrow band Analysis done on captured data to identify cavitation inception speed
3. Uses AI to identify inception of cavitation, tonals and correlate the tonals to data analysis reports
4. Magnetic data analysis is used to identify suboptimal surface, performance of vessel
5. Helps to reduce ship's acoustic and magnetic signature optimizing stealth
6. Automation of entire process and handling big chunk of data



Cyber Security

31. Android Malware Detection Solution

This is a comprehensive system to analyse the lacks and weaknesses of the android applications. It reports the detected malwares in a user-friendly format, performs audits and exploits (for vulnerability proof of concept purposes) Android applications.

Malware detection is done using deep learning libraries (RNN and LSTM). A sample dataset of 6000 Android applications is used to build a vulnerability scanner model using deep learning. This will predict the vulnerability for a new application fed to the model.

Set of tools include:

- Android Vulnerability scanning and exploitation
- Malicious application detection
- Android App Review Reporting

The solution can be used by Armed forces and also civilian domain applications that require Malware detection and analysis features.



A decorative graphic of a circuit board pattern in light blue, consisting of various lines, dots, and shapes, is positioned at the top and bottom of the page. A solid dark blue horizontal band is centered across the page, containing the title text.

Human Behavioural Analysis

32. Driver Fatigue Monitoring System

Assessing driver fatigue in critical conditions is an indispensable tool, especially in the armed forces.

A real-time, non-intrusive AI-based system can predict accurately and identify situations where drowsiness and fatigue in the driver may be setting in. Detection is based on performance.

The intelligent system detects the onset of drowsiness in driver, while the vehicle is in motion. A camera inside the cabin films the driver continuously. A detection system analyses the movie frame by frame and determines whether the driver's eyes are open or closed. Detection is done by continuously looking out for symptoms of drowsiness, while considering physical cues including yawning, drooping eyelids, closed eyes and increased blink durations by using percentage of eyelid closure over the pupil over time (PERCLOS) algorithm.

DFM system involves two steps firstly, face detection with various facial landmarks and secondly, detecting drowsiness based on various analytics such as blinking, opening of mouth for yawning, movement of head etc. Face and landmark detection are based on image processing techniques.

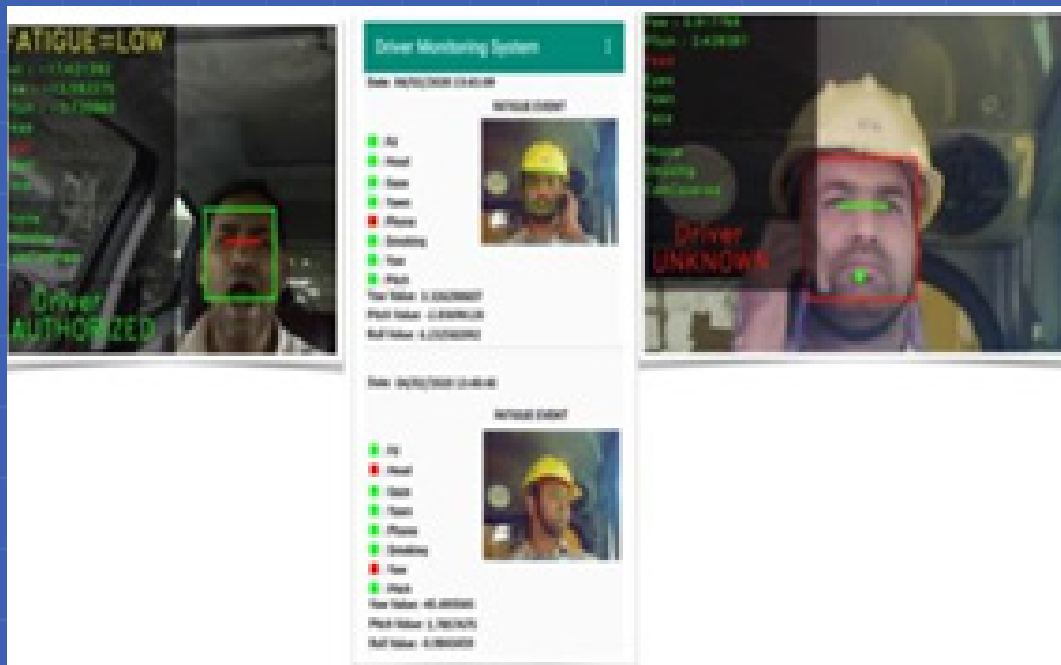



Intelligent Monitoring Systems

33. Project Seeker – Facial Recognition System for Population Monitoring, Surveillance and Garrison Security

The seeker system is a self-contained, AI-based facial recognition, surveillance, monitoring, and analysis system for identification & tracking of threats for counter terrorism, continuous surveillance, and monitoring of disturbed areas.

Additionally, the system can be employed for ensuring state-of-the-art security of critical military/civilian establishments and monitoring at border-crossing points.

The AI-powered analytics module enables processing of Intelligence data from various sources to identify and track movement of terrorists and anti-national elements aided by accurate information collection.

Application of System:

- Counter Terrorism,
- Threat Monitoring,
- Creation of Secure Zones,
- Monitoring of Disturbed Areas,
- Intelligence Analysis,
- Border Monitoring,
- Secure Places of Strategic Importance

Unique Features:

- Indigenously Designed, Developed, and Deployed
- No Internet Connection Required
- Proprietary Data Security Layer
- State of Art AI Deep Learning Facial Recognition Algorithm

- Combined Intelligence Data Capture and Analysis System
- Able to Operate in Wide Range of Environmental Conditions
- Continuity and shareability of Intelligence Data

How it will Serve the Nation -

- Efficient and Effective Surveillance
- Psychological Dominance on threats and Anti National Elements
- Aids the Pre and Post Incident Analysis
- Increases the Area of Surveillance
- Reduces Manpower Requirement

STEP 1 : Field ready system is setup in op area/MCP location



STEP 2 : Data of personnel in area is captured initially



STEP 3 : Test of multiple individual is checked against DB

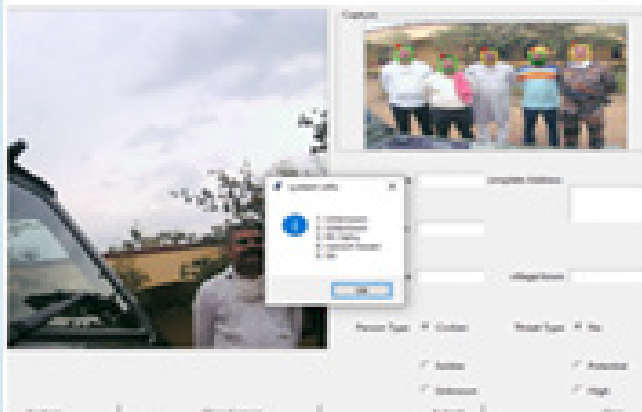

34. PROJ V-LOGGER

V-logger Vehicle Tracking System

Weaponising the vehicle has been an emerging trend amongst the Antinational Elements in the recent past. The Pulwama attack of 2019 is one of the recent incidents that shows such a trend. Despite deliberate measures, identity of a suspicious vehicle still remains a challenge to the units/formations deployed on active duty. As there is a need to build an AI-based Suspicious Vehicle Detection System which can automatically identify a vehicle based on its license plate and extract the identity of the vehicle which can serve as a decision support system with an aim to enhance human capability and efficiency of troops deployed at vehicle check posts.

The innovation is equipped to work on any existing camera inputs like webcam, bullet cameras, dome cameras etc.

V-Log Vehicle Tracker is a state of art AI based software tool for detection and tracking of Civilian vehicles using license plates. The system uses latest state-of-the-art AI & Deep Learning algorithms for real-time vehicle detection from live video feeds. The system is capable of identifying individual vehicles from moving traffic in real time. It extracts the vehicle info to include number plate, make, model, colour etc., on-the-fly and corroborates the details with registered formation vehicle database for cross matching the identity of the vehicle. The system is also capable of raising an auto alarm in case of any identity mismatch in vehicle credentials amounting to suspicion.

Salient Features.

- a. **High Accuracy.** Supports standard and non-standard Indian number plates with detection accuracy over 90%.
- b. **Two/Four Wheeler Sp.** V-Logger System features seamless no plate recognition of two/four-wheeler non-std number plates.
- c. **Detection on Moving Traffic.** System is Capable of detecting the number plates on real-time continuous fast moving traffic.
- d. **Network deployment.** V-Logger supports multiple cameras over a network to cover a stretch of road.
- e. **Analytics & Insights.** The analytics capability helps to gain more depth insights on moving pattern of vehicles over an Area of Responsibility.
- f. **Blacklisting & Manual Entry.** Facility to blacklist a known illegitimate vehicle based on intelligence/civil police inputs.
- g. **CPU Optimized.** The system is optimized to work in a normal desktop/laptop without the support of a dedicated GPU machine as compared to former version.



35. Face Recognition System under Disguise

'Face recognition in the wild' on surveillance camera feeds is a difficult problem to solve due to the low resolution of the images captured from the cameras. This problem becomes even more challenging to solve with the added complexity of various facial disguises, crowd occlusions and varied illuminations. Face Recognition System under Disguise (FRSD) aims to solve these challenges.

The objective of FRSD is to develop a system which can be used to identify anti-social elements with or without disguise in low-resolution surveillance camera feeds. The algorithm has been trained in such a way that the face recognition system can see through several disguises like face-masks, beard, moustache, wigs, sunglasses, head-scarves, monkey-caps, hats, etc. Apart from the disguises, the system also considers different lighting conditions, shadows on face, crowd occlusions, etc.

The system can be deployed at restricted/secure zones for the purpose of live video surveillance. It can also be deployed at public places to recognise anti-social elements. The algorithm can also be used by security agencies for robust face search across large repositories.

The system is designed to ensure scalability across multiple GPUs and servers. In addition, the system is optimized to ensure maximum utilization of GPUs and thus can support multiple surveillance cameras on a single GPU. The system comes with a flexible video analytics suite with number of additional surveillance applications like people counting, geo-fencing, fire detection and collision detection.



36. Segmentation of Satellite Panchromatic Videos

The module performs automatic land cover classification of gray-level satellite imagery to produce four land cover classes namely – water, forest, bare land and urban area which includes buildings and vehicles.

It is able to segment a panchromatic image using only intensity information into four different land cover types. Accurate classification of even very small areas (15x15 pixels) in the satellite image is achieved through multiple level texture analysis using a state-of-the-art machine learning algorithm. The same method is capable of scenario classification in panchromatic as well as Google Earth images.

This solution has been successfully deployed in the Battlefield Surveillance System (BSS) for surveillance of border regions. This aids the defence personnel to quickly identify any remarkable changes in the border regions based on satellite images. It caters to panchromatic images with different types of land cover classes and can be used in different video surveillance applications.



37. AI based 360° Surrounding View Monitoring System

Operator visibility can be limited due to blind spots around over-sized machines, often made worse by the harsh working environment; terrain, weather or low light. 40% of fatal accidents on quarry sites are caused by moving vehicles and 70% of collisions occur at low speed because of poor visibility. Mirrors and single-view cameras help to see blind spots, but even with this extra assistance, the driver may still not see everything in the vehicle's path.

An AI-based 360-degree, intelligent camera monitoring system assist low-speed maneuvering by providing the driver with a complete surround view of the vehicle in real time.

The system works with four ultra-wide-angle cameras that each covers one full side of the vehicle with a viewing angle of over 180°. High-mounted on the front, rear and sides, the calibrated cameras capture all of the surrounding area including the blind spots of the vehicle.

The four live images are simultaneously sent to an electronic control unit (ECU) where they are instantly processed, combined, blended and stitched. The distortion from the wide-angle camera lens is also corrected before delivering a clear, single, smooth, real-time image onto the driver's monitor.

The system has an in-built digital video recorder and images/video can be viewed later for analysis in case of any accidents/operational issues. It can be integrated with Radar based proximity warning system. The system will alert the operator to view the camera whenever any objects/persons are detected.

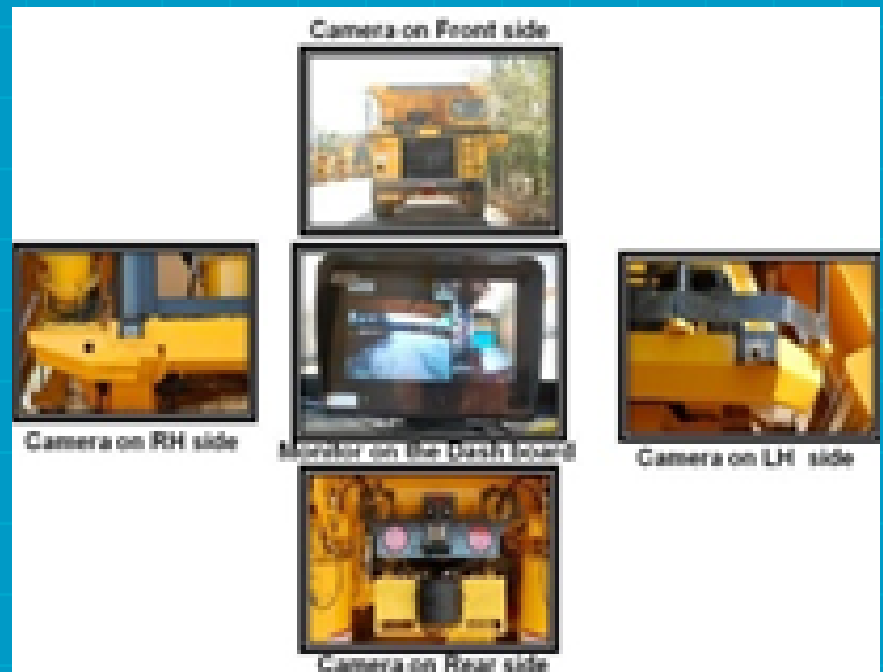

38. HUMS Ground Station

Health and Usage Monitoring System (HUMS) for Helicopter Maintenance has been developed for performing Condition Based Maintenance (CBM) instead of Fixed Time before Overhaul (TBO) based maintenance.

The system uses recorded vibration data onboard the helicopter and processes it to compute various Condition Indicators (CIs). These Condition Indicators are then used by the AI-based algorithm to compute the Remaining Useful Life (RUL).

Unique Features:

- Replaces Time before Overhaul (TBO) based maintenance with Condition Based Maintenance (CBM) based on Remaining Useful Life (RUL).
- Results in reduction in unplanned downtime of the helicopter; thereby enhancing fleet availability.
- Adaptable to other helicopter platforms like LUH, LCH etc.

Marketability & Export Potential:

- Condition Based Maintenance (CBM) is steadily gaining importance all over the world. The HUMS ground station can be packaged with the helicopter platform sales being targeted by HAL to countries like Philippines.
- HUMS Ground Station can also be offered to countries flying ALH like Mauritius.

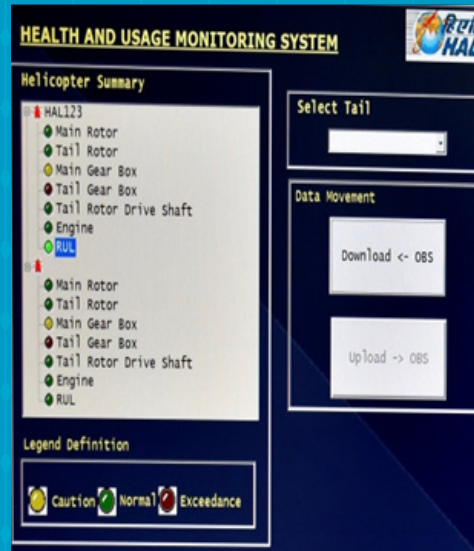

REMAINING USAGE LIFE STATUS SUMMARY

TAIL NO.: HAL123

PART NAME	Remaining Usage Life	%
MGB TPTO BEVEL PINION 17T	<div style="width: 31.600%;"></div>	31.600%
MGB TPTO COLLECTOR GEAR 111T	<div style="width: 28.500%;"></div>	28.500%
MGB TPTO HELICAL GEAR 67T	<div style="width: 31.870%;"></div>	31.870%
MGB TPTO HELICAL PINION 33T	<div style="width: 26.830%;"></div>	26.830%
TGB AXIAL 19T	<div style="width: 19.650%;"></div>	19.650%
TGB AXIAL 49T	<div style="width: 21.650%;"></div>	21.650%
TGB RADIAL 19T	<div style="width: 17.600%;"></div>	17.600%
TGB RADIAL 49T	<div style="width: 20.480%;"></div>	20.480%

39. AI-Based Satellite Image Analysis

This is an indigenised solution that provides comprehensive real-time geospatial situational awareness backed by cutting-edge R&D. Generate one-click actionable insights supporting multi-sensor, multi-platform data fusion. Utilises state-of-the-art data-processing and advanced Artificial Intelligence techniques for multiple aerial and space platforms. Fine-tuned for a wide range of security user requirements.

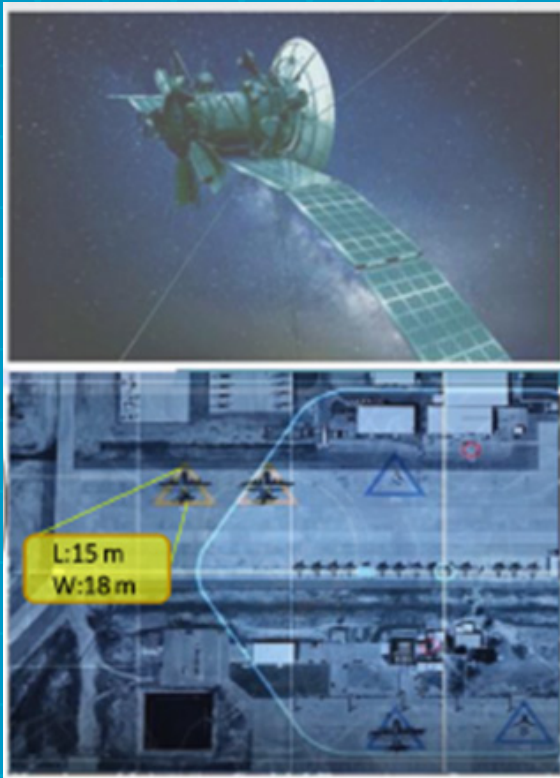

40. AI-Based Technique for Prediction of Atmospheric Visibility

Knowing and having access to meteorological data is extremely vital to the Armed Forces.

This solution by Puzzles, predicts real-time, location-based visibility forecasting. The technology uses METAR data along with satellite and meteorological data based on latitude, longitude and altitude.

Meteorological data like temperature, precipitation, relative humidity, wind speed, wind direction, visibility and particulate matter (PM10, PM2.5, etc.) would be correlated with the visibility range.

Using a statistical concept called time series and ML algorithms, visibility forecasts can be predicted in real time. Long

and short-term memory (LSTM) networks are a version of recurrent neural networks (RNN), that make it easier to remember past data in the memory. LSTM is well suited to classify, process and predict time series for a given time lags of unknown duration.



PUZZLES

Name of the Founder:
Apoorva M Ankad & Dr. Hemant Kumar
T E

Challenge (DISC / OC):
DISC 4, (Prediction and Forecasting of Atmospheric Visibility)

Sector of Innovation:
AI based Meteorological Services for Aviation

Technology Used:
Computer vision, Artificial Intelligence, Machine Learning, Data science etc

Product Details:
Puzzles solution to predict the real time location-based visibility forecasting, uses METAR data along with satellite meteorological data based on latitude, longitude and altitude. Meteorological data like temperature, precipitation, relative humidity, wind speed, wind direction, visibility, PM10, PM2.5, etc. would be correlated with the visibility range. Using time-series machine learning algorithms, visibility forecasts can be predicted for real time. Long short-term memory (LSTM) networks are a version of recurrent neural networks (RNN), that makes it easier to remember past data in the memory. LSTM is well suited to classify, process and predict time series for a given time lags of unknown duration.

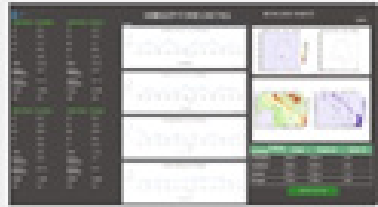

Puzzles Technologies India Pvt. Ltd.

41. Chimera-22 Smart Camera

Chimera-22 AI Smart Camera powers the next generation of vision analysis. Indigenously manufactured, it is an integration of NVIDIA Xavier NX computing module and IMX sensors. Giving the best of worlds in processing power and resolution.

Unique Features:

- Edge AI Capability
- Plug N Play
- Cloud Connectivity
- Real-time compute capability
- Customisable Dashboard
- Smooth 3rd Party Integration

Vision Applications:

- Security & Surveillance
- Access control & usage charging
- Product quality inspection
- Defence Applications
- Drone Detection
- Robot Guidance
- Metrology
- Post-facto video analysis for claim adjudication / crime investigation.
- Intrusion Detection
- Edge AI enabled, rugged military grade Smart Camera which is designed & manufactured Indigenously in India for defence applications



42. Deepsight Canopy Inspection for Fighter Jets

Deepsight is an AI-based machine vision system for automatic inspection of surface defects. Manual inspection and grading are more subjective and error-prone and not suitable for large number of items to be graded.

Deepsight is the first deep learning-based cosmetic inspection and grading system that provides the end user with accurate and flexible inspection operating and grading methodology.

Unique features:

- Inspects fighter aircraft canopy for clear visibility to the pilot
- AI system identifies and measures Glass Silvering and other defects such as cracks, dents and scratches on the canopy
- The system can measure the depth of the dents with up to nanometer precision
- The system allows Supervisors to set criteria for Pass and Fail of the canopy.
- SCIS provides accurate and dependable evaluation data
- Ruggedised monitoring system

Key Benefits:

- Consistent and accurate grading of aircraft canopies as per defined criteria
- Eliminate subjectivity involved in manual grading operations
- Laser Inspection system should get coordinates from the Optical inspection system

- Configurable solution to suit product size and defect specifications
- Optical inspection system scans the surface of the Canopy using Camera.
- Deep learning algorithm for continuous improvement

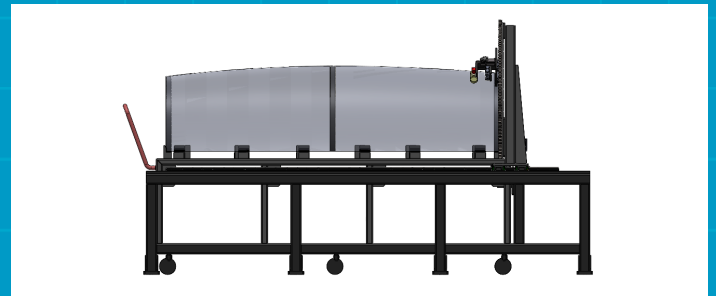



IoT / Smartcities

43. Internet of Battle Things (IoBT): Smart Helmets

The urban combat scenario is always challenging due to its constrained space of operation and the sheer unknowns of the area of operation. Hence any form of real-time situational awareness increases the chances of success manifold. To address this need for real-time situational awareness the “Smart Helmet” can capture the 3D information of any unknown environment in real time and assist in various decisions.

The “Smart Helmet” comprises of an optical sensor mounted on the helmet of an active combat soldier which in turn is connected to a wearable backpack computer of small form factor. The sensors capture the 3D information of the environment in real time and the software (running on the computer) using an Artificial Intelligence algorithm, generates a 3D map of the same environment. From the generated 3D map semantic locations of various entities (doors, windows, gates etc) inside the unknown environment can be determined along with their approximate dimensions. This information helps in deciding entry and egress points of an unknown environment.

In addition to this, the generated 3D map can serve as a “Local Positioning System” for conflicted and remote areas where we might have “No GPS” or “Low GPS” scenario. With the help of the “Smart Helmet”, members of a combat team or search and rescue team can precisely determine their own 3D positions in real time. This positioning system has an accuracy of less than 100 cm and has no dependency on external sources e.g., GPS. The positional information of each multiple combat agent wearing the “Smart Helmet” are relayed to a central command center at a rate of 10Hz using a wireless backbone. This helps in tracking multiple combat agents inside an unknown environment thereby creating a comprehensive situational awareness for decision making.



44. Automatic Number Plate Recognition for Smart Cities

Automatic Number Plate Recognition (ANPR) technology is indigenously developed with a high accuracy for Indian vehicles. The system is able to detect and recognise licence plates of different types of vehicles like two-wheelers, auto rickshaws, cars, trucks, buses and military vehicles from the live traffic feed captured by ANPR camera operating on a day-night basis.

This is an end-to-end solution including vehicle image acquisition, real-time recognition of licence plate and storing relevant vehicle details in a central repository. It can be deployed on edge devices as well as a centralised server as required. The ANPR module is an integral part of Smart City solutions provided by BEL.

ANPR finds several diverse applications such as access control, parking management, tolling, user billing, traffic management, policing and security services, red light and lane enforcement. It helps in automating vehicle inspection systems and traffic management systems. Thus, it helps in ensuring security and enabling a hassle-free life for citizens.

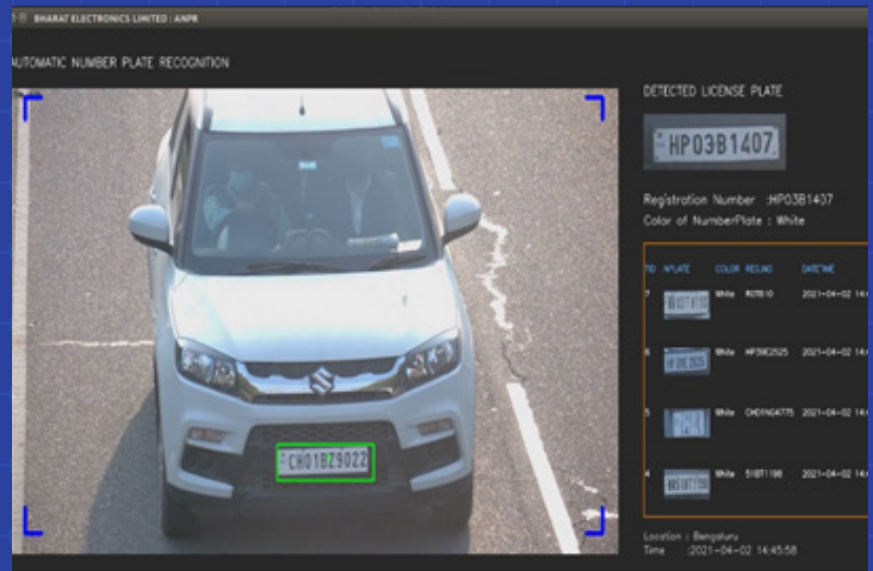

45. AI Enabled Adaptive Traffic Optimization Solution

In the current scenario of smart cities and connectedness, the world is looking forward to new AI-based traffic analytics and management system that enables governments and Department of Transportation, to autonomously monitor growing traffic. Traffic congestion is an ever-increasing, non-productive problem in towns and cities around the world. Further, it reduces regional economic health.

Hence there exists a need for adaptive traffic control solutions that help smart cities move towards faster response to accidents, improve transportation infrastructure and reduce congestion. In this direction, BEL developed a comprehensive AI-enabled Collaborative Multi-Agent Reinforcement Learning based adaptive traffic optimisation solution that aims to reduce travel time and delay at traffic signals and also to minimise the average waiting time throughout the network of traffic signals. This solution is capable of adjusting signal timing parameters in response to traffic fluctuations in multi-agent networked junctions.

It can be deployed at traffic junctions as part of Smart City Implementation.



A decorative graphic of a circuit board pattern in shades of purple and blue, featuring various lines, dots, and nodes, extending across the top and bottom of the page.

Lethal Autonomous Weapon Systems

46. Smart - Counter Measure Dispensing System (CMDS)

CMDS protects aircraft / helicopters against incoming Infrared / Radar guided missile threats by dispensing payloads (Flares / Chaffs) based on the inputs received from various sensors installed on aircrafts.

What does SMART-CDMS do? When the aircraft flies over an enemy territory, which is prone to attacks, SMART-CMDS automatically dispenses appropriate type and number of payloads in a suitable sequence against active threats, based on the inputs available from the sensors and mission computer.

While dispensing suitable firing programs against active threats, SMART-CMDS records the relevant firing data along with the geographical position which will be later invoked to decide suitable firing sequence in that particular location to preempt previously known threats.

SMART-CMDS will learn over a period of time to dispense payloads intelligently while passing over such threat locations in future sorties.



47. Adaptive Intelligent Front Towing Solution for Artillery Gun

Particular system provides synchronization of speed-dependent and turning radius dependent movement between a driver component and a driven component

Gun can negotiate hair pin bend with ease

It provides controlled motion to gun while negotiating turn

Reliable and redundant solution

Overall structural weight for towing arrangements has been reduced

Features:

- With proposed configuration turning circle radius equal to and less than towing vehicle alone has been achieved.
- Road width required drastically reduced than earlier configuration.
- Can be used in any terrain with side and ground slopes



Logistics & Supply Chain Management

48. PRO-HM+ (AI-in SCM and Logistics)

Monitoring the health of an aircraft, its components and systems is critical. Predictive monitoring can help avoid defects, hazards and delays in the operations of the aircraft.

The current practice of conventional, condition-based monitoring practices can provide information about a defect only after its occurrence. This can prove to be ineffective and could lead to unsafe operation of the aircraft.

It is, therefore, necessary to identify a method to monitor the health of the aircraft components and system to avoid an impending failure before occurring.

ProHM+ is an AI based in Aircraft Health Monitoring software product that used data analysis techniques to identify trends, patterns, and relationships, which will enable prediction of aircraft behavior, equipment failure and other future events.

ProHM+ converts acquired data into operational and business intelligence. Descriptive, predictive, prescriptive and prognostic layers of data analytics monitor the trend of operation and predict the maintenance requirement with a high confidence level. This can maximize the uptime of the asset and reduce the total cost of ownership.



A decorative background pattern of light blue circuit board traces and nodes, extending across the top and bottom of the page. The traces are composed of thin lines that branch and connect to small circular nodes of varying sizes. A solid dark blue horizontal bar is positioned in the center of the page, containing the main title text.

Manufacturing and Maintenance

49. Artificial Intelligence Based Predictive Maintenance Suite

Ships and other platforms are typically complex systems containing a large number of subsystems and components, operating in a harsh environment. These systems are presently maintained by performing a scheduled maintenance (hourly, daily, monthly and yearly) or, reactive maintenance.

This is not only a costly process, but it also limits the availability of the system. 'Reduced downtime, high availability with reliability' of the platforms is one of the prime requirements for the Armed Forces.

Predictive maintenance, also known as condition-based maintenance helps address this situation, in an optimum manner. The AI-based Predictive Maintenance (PdM) Suite uses data from various sources like historical maintenance records, sensor data from machines, and weather data to determine when a system/equipment/machine will require maintenance. Leveraging real-time asset data plus historical data, the AI system can predict potential failures in real-time thereby decreasing machine downtime.

The key benefits of AI-based PdM Suite are:

- Optimisation of available resources
- Reduction in equipment downtime
- Adaptive maintenance routine
- Early detection of potential faults
- Fleet level consolidated visibility
- Comprehensive Spare Part Management

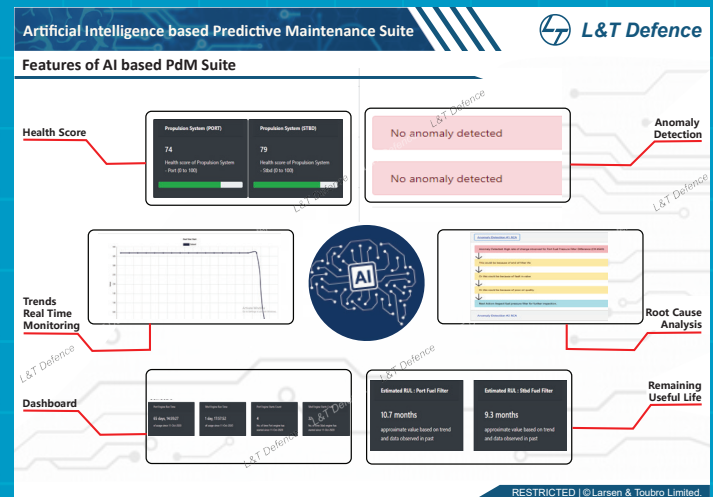

50. Predictive Maintenance for Gun Fire Control Systems

Where AI scores is being able to predict breakdowns, downtime and speed up repairs or replacement if needed. Both time and speed are extremely crucial especially if it comes to gun control systems being operational at all times.

Lynx-U2 is a Gun Fire Control System which has been successfully deployed in more than 35 Systems as the Ship's Last Line Self Defence across Eastern and Western Naval Commands. It interfaces with various on-board sensors and Long/Short Range Guns.

The AI/ML-enabled, real-time predictive system has been developed and deployed to predict better maintenance of PCBs by using the concept of detect anomaly /failures/early warning and asset conditions parameters.

The software solution is useful in a wide range of systems, where the system's health conditions need to be anticipated much prior to avoid severe damage / malfunctions.

Advantages of using Predictive Maintenance:

- Maintenance of system based on predictive rather than scheduled maintenance.
- Monitoring all critical sensor data of assets.
- Avoiding failure of LRU's w.r.t to voltage spikes and temperature issues.
- Proper planning and replacement of spares.
- Minimise downtime by continuous monitoring and taking proper actions to prevent failures.

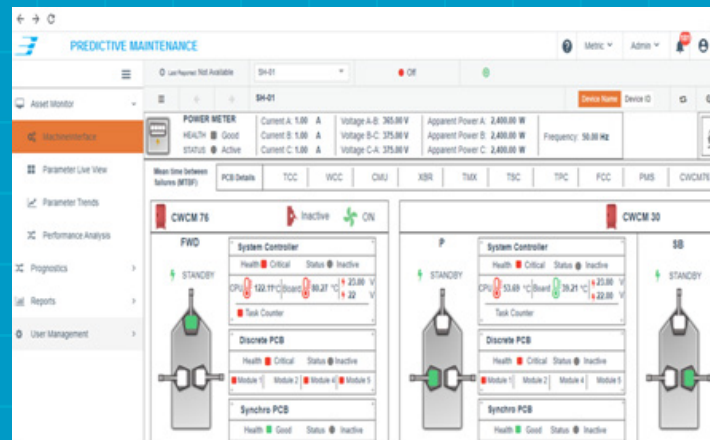

51. AI Based Predictive Maintenance of Delhi Metro Rail Equipment

A smart (AI) system not only works smart but prevents downtime on its own.

In a system with many components working together and influencing each other's lifetimes, it becomes a challenge to find the right moment when maintenance should be performed so that components are not prematurely replaced and the whole system stays functioning reliably. To achieve this outcome, a comprehensive solution is being developed at BEL. Using Machine Learning (Regression and Classification algorithms) algorithms have been developed that are capable of anomaly detection and survival analysis that would help in achieving predictive maintenance schedules / metrics.

This product is unique for its functionality of predicting equipment failure based on equipment health, historical

patterns of occurrence of failures and periodic maintenance schedules. These predictions are utilised for predictive maintenance of metro equipment, in order to enhance their operational duration. This product is being utilised for the Delhi Metro Rail Corporation (DMRC). Using this solution, downtime of equipment shall be reduced, which will further ensure user convenience. Additionally, maintenance cost is reduced by proactively maintaining the module before occurrence of any major failure.

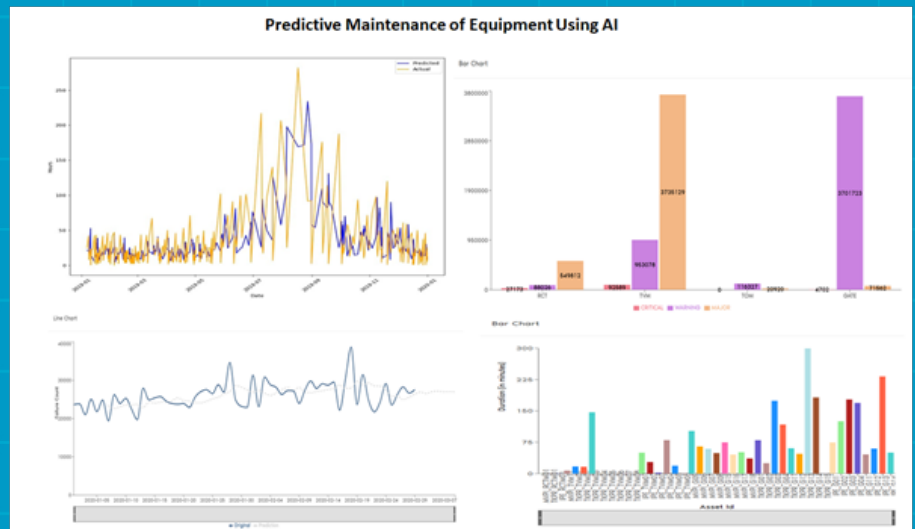

52. Alloy Development through Artificial Intelligence

The application of intelligent data analysis methods in materials science research can greatly assist in optimizing the virtual screening space for new materials and speed up the process manifold as compared to classical ways of finding/improving new materials.

The goal of the project is to design a framework for new alloy design using Artificial Intelligence. The preliminary studies were conducted around the composition of H13 tool steel. The focus of the targeted application is to achieve low thermal expansion coefficient with considerable strength of the steel using Machine Learning.

In future, this framework can be used for any other alloy systems like superalloys, titanium alloys, with respect to specific applications.

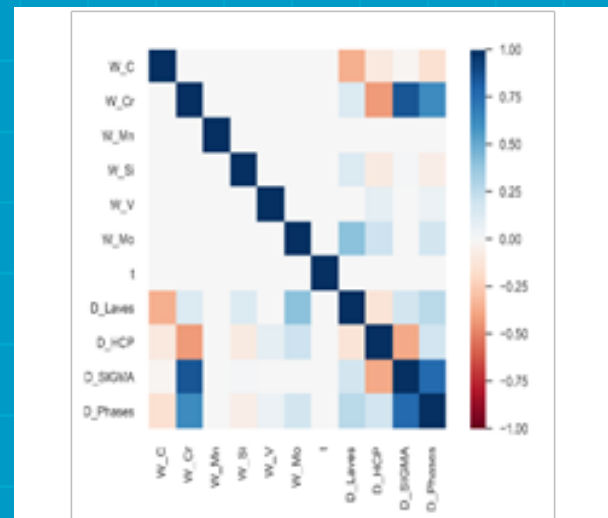
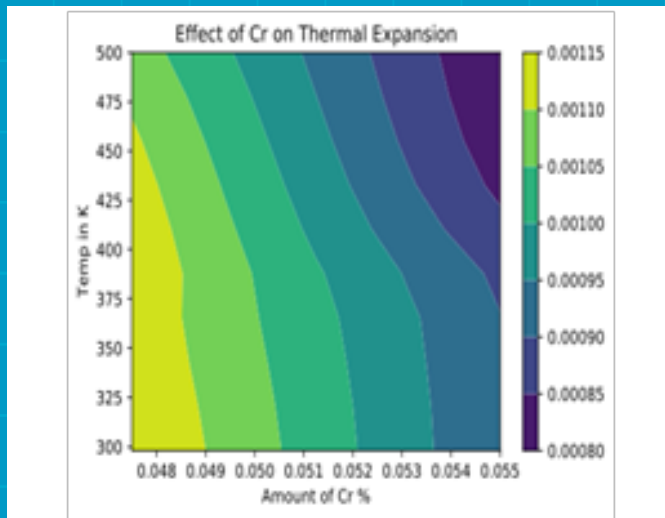

53. Predictive Maintenance of Mining Equipment Through Data Analytics and Telematics Enabled System

This AI-based system uses modern, analytical techniques to decrease cost of maintenance and reduce downtime. It does so by early identification of imminent equipment failure. It employs Telematics, the remote monitoring of equipment and vehicles using a “black box” that collects, stores data and sends it via cellular or satellite to a cloud server and, ultimately, software accessed by the end user.

Telematic Solutions commonly provide detailed machine data, including parameters like engine oil, transmission and brake temperature, engine RPM, speed, tire pressure, fuel consumption and emission levels to name a few. This data can be analyzed and combined with historical data and deep industry knowledge to predict an upcoming failure so that planned maintenance can be performed. This avoids the cost and delays associated with a random failure and helps operators determine when maintenance is needed rather than schedule them based on time or miles spent.

Key features:

- External Device Interface Over Can 2.0, J1939, OBD2
- Immobilizer activation By SMS
- Over-the-air Firmware and Data Update (Two Way Communication)
- Easy-to-understand And Customisable Reports
- Location Report and Route Playback
- Alarms and errors Information
- AI based Predictive maintenance algorithms.
- Customers can get their own machines records automatically with telematics.
- Realize the operator’s working status.
- Proactively addressing problems= smoother operations
- Decreasing the risk of unexpected events happier customers

- Detecting issues before failure= lower costs, improved safety
- Increasing uptime= more opportunity to generate revenue

Unique Features:

- The AI software analyses real-time information along with historical data to predict whether the equipment will fail.
- AI algorithms easily spot any changes, which may indicate failure, long before it could affect the vehicle’s performance.
- Predictive analytics for early warning.
- Artificial intelligence takes the guesswork out of preventative maintenance. Measurement of part depreciation saves costs and time

54. Condition Monitoring System for Shipboard Equipment (Main Engine)

GSL and Infosys have jointly developed a Condition Monitoring System (CMS) for Main Engines On-Board OPV class ships using Artificial Intelligence (AI). The system identifies anomalies and predicts the time of likely failure enabling predictive maintenance of main engines installed on board. The system brings together the best of engineering and data science technologies to solve the complex problem of engine health prediction.

Unique Features:

The Condition Based Monitoring system for Main Engine is a predictive maintenance tool for health monitoring and failure prediction of Marine Engines which is unique in providing following capabilities to ship's crew:

- Assess and monitor Engine Health continuously
- Predict failure
- Reduce maintenance and operational costs
- Improve inventory carrying levels
- Enhance performance and safety of ship



55. AI-Enabled Evaluation of Welding Defects in X-rays of NDT

This AI enabled intelligent system has replaced the manual evaluation/inspection system of weld defects in X-rays of NDT. The intelligent system encompasses AI / ML technologies for carrying out the inspection of weld defects from X-rays of NDT. The software has an accuracy of 90%.

Unique Features

The use of this AI software would decrease the dependency on Human expert and eventually curtail the requirement of Human interface for evaluation of RT Films derived from X-rays from weld joints.



Operational Data Analytics

57. Operational Data Analytics for Naval Platform

A large amount of data, the ability to process it and gain valuable insights from it is critical.

The “Platform Sensor Grid” stores a large amount of sensor data from all the naval ships. It uses big data analytics techniques with advanced statistical and machine learning algorithms. This provides an effective and efficient target analysis for various mission critical tasks. It finally predicts sensor performance and recommends best available naval ships for mission categorisation.

The sensor grid comes up with a dashboard visualisation that enables the user to effectively comprehend the vast amount of data at a glance. The data insights provided by the Platform Sensor Grid aids the naval decision-makers in an effective and accelerated decision-making regarding mission categorization.

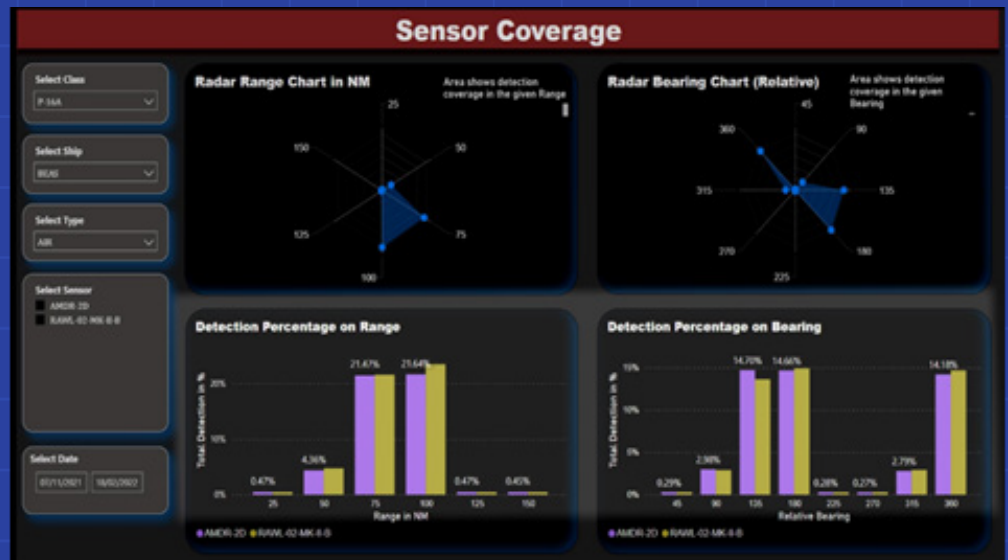

58. AI Enabled Automatic Information Extraction and Synthesis

In today's digital world, the Internet, smart devices, IoT has caused an explosion of data. Human internet activity has become a tremendous source of potential information. This information from diverse sources would be impossible for humans to manually process and understand. Hence BEL developed a comprehensive AI enabled Automatic Information Extraction and Synthesis.

Functionalities:

- a) Machine Comprehension
- b) Video Summarization
- c) Fake image detection
- d) Speaker Diarization

Some of the techniques that are employed for automated information extraction include Naive Bayes classifier, Support Vector Machine, Decision Trees, Neural Network, etc.

Features:

- Automated Information extraction from a block of text either from text file or pdf. The system uses BERT NLP model to learn the context of the text from and provides the answer for the question with in the context of the paragraph.

- The system summarises a video with the key frames, so that the user need not see the whole video.
- System is capable of finding the fake image
- Speaker Diarization is implemented, that indicates which speaker spoke at what interval of time

Potential users:

- All Law Enforcement Agencies
- Military/ Paramilitary / police forces
- Users of C4I / C5I applications
- Intelligence collection and Analysis agencies.





Perimeter Security Systems

59. Sarvatra Pehchaan – AI Based Intrusion Detection & Integrated Command Station

Intrusion and detection is a critical component of any defence strategy.

Earlier, multiple Sensors deployed on the AIOS lacked common operating system and the feed was not integrated on a single dash board. Video footage needed to be monitored manually. An AI integration system to monitor & process multiple feeds was sorely needed to improve efficiency and minimise errors.

SarvatraPehchaan considers a fusion of sensory feeds from multiple imaging systems and sensors on a single dashboard. AI-based video analytics techniques are used for anomaly detection, allowing rapid intervention.

Features:

- Integrated AI based Intrusion Detection System and Integrated Command Station.
- Fusion of multiple sensor feeds in single dashboard.
- Automated AI based anomaly detection.
- Indigenous Software.
- User interface application.
- Scalable for future upgrades.
- Time stamped Intrusion Detection and Identification.

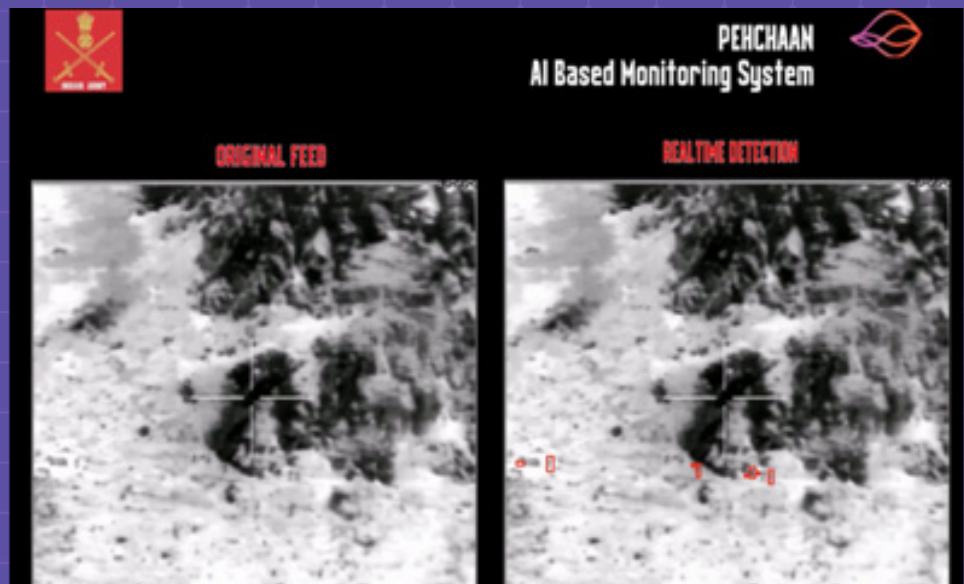

60. AI-Enabled Forensic Search for Videos

AI-enabled technology is making a big contribution in the areas of surveillance.

It's a well-known fact that all surveillance cameras record video 24x7. But to view any particular or isolated event of interest, the operator needs to view the complete data which can be an exhaustive and time-consuming exercise.

AI-enabled forensic search now makes it possible to view the events in the entire time interval according to a set of filters. To perform a selective search, different search criteria options are provided to the user via forensic search user interface. Using this technology, camera-stream recorded videos are processed using AI techniques to identify the objects in the scene. This process runs continuously in the background. All the identified objects' metadata and their properties are stored in the database for further analysis. The link to the corresponding video file is also stored in the database.

Key features:

- Identification of intrusions hotspots,
- Visualise intrusion timelines,
- Perform precise search for objects and activities
- One-click to export shortened summary video

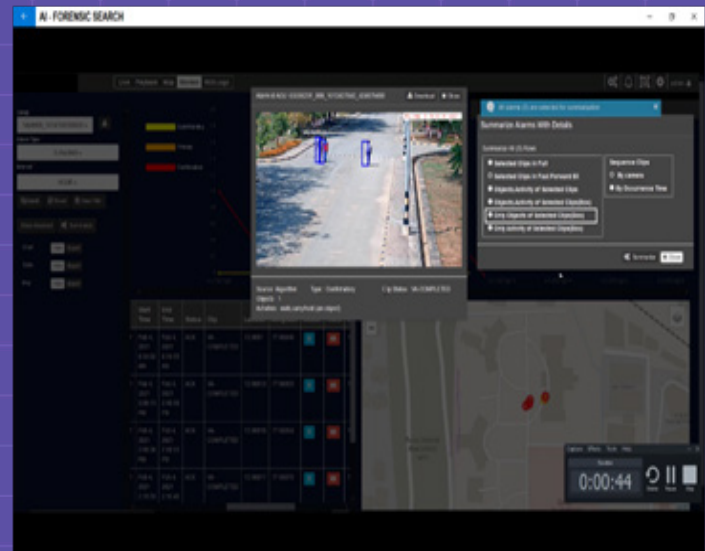

61. AI-Enabled Gesture Recognition

Being able to positively identify enemy threats through movement detection of human forms is an indispensable tool in the hands of the armed forces.

The Artificial Intelligence (AI) enabled gesture identification system uses deep learning technology in identifying various human gestures like human walking with or without a gun, human crawling with or without a gun and human crouching with or without a gun. The system can be easily integrated on a network of IP enabled cameras.

replace with Applications:

a) Securing the border with neighbouring countries which has to be monitored continuously for illegal and dangerous activities like terrorist intrusion, smugglers or illegal immigrants.

b) Automatic identification of human gestures near the perimeter of defense establishments. Monitoring the activities effectively which allow the identification of dangerous threats for taking preventive steps.



62. Audio Doppler Based Object Classification

Artificial Intelligence makes it possible to identify and classify the nature of moving targets.

Automatic Doppler based object classification system determines the nature of a target moving in the radar's field of view using its Doppler return signal.

The five classes considered for ground target recognition are: Single Moving Pedestrian, Group of Moving Pedestrians/ Animals, Moving Wheeled Vehicle, Moving Tracked Vehicle and Unclassified.

The Automatic Doppler based system aims at replacing the human operator, thereby avoiding a very tedious task for the operator and in turn making the system independent of operator fatigue and health level. This product is useful in classifying the behaviour of ground intrusions using radar, which can alert the ground forces.

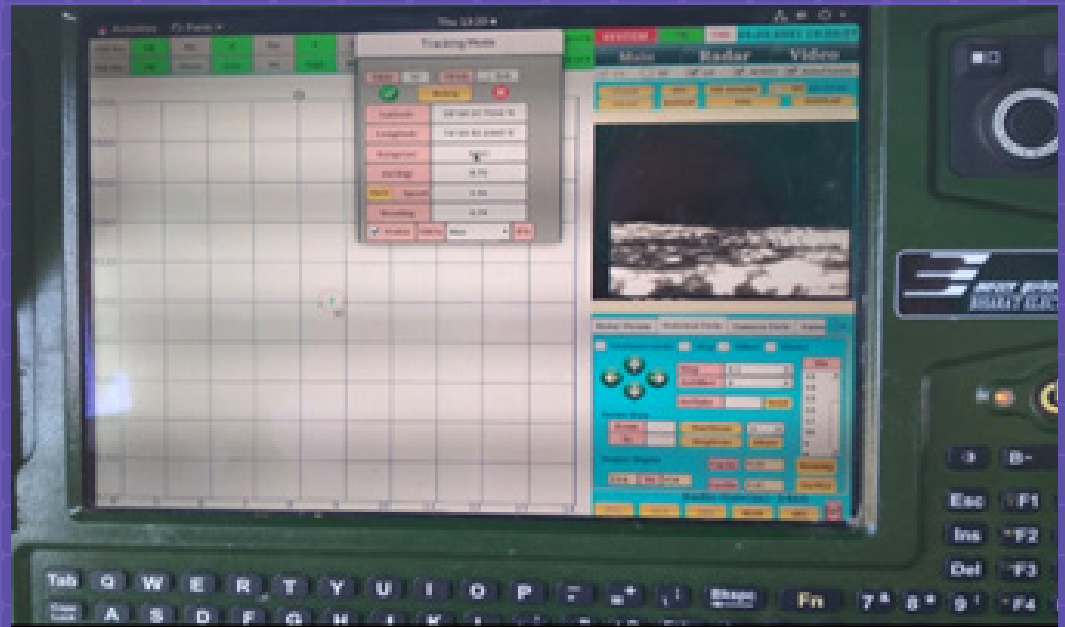



Process Flow Automation for Large Systems

63. AI-Based Automation of Water Sprinkling System

The AI-based Water Sprinkler Controller will monitor dust concentration in open cast mines by IR camera, process the data using Artificial Neural Networks and actuate the output to switch ON the corresponding solenoid driver to do the desired water Sprinkling operation(Auto mode).

In manual mode, it takes voice commands from the water sprinkler equipment operator and actuates the output to switch ON the corresponding solenoid driver.

The operator can also use front panel keys to switch ON the required water sprinkling operation in Manual mode. There is a provision for Digital I/O module to monitor safety parameters of the system and to protect the pumps.

Key features :

- Voice command provision for Manual Mode operation.
- Various safety logics for protection of water pump and hydraulic motor.
- Operator independent system for effective operation of water sprinkling which in turn saves water, pump and hydraulic motor.
- Provision for IoT (Internet of things) for remote monitoring and configuration through Bluetooth Data Hub, WIFI/LAN (GSM/CDMA module).

The system consists of following components:

1. Controller with inbuilt camera
2. Wire harness



Unique Features:

- The monitoring of dust concentration in open cast coal/ iron ore mines by using Artificial Neural Network and IR-based camera.
- The system will monitor the real time dust condition based on Neural Network by camera and actuate the solenoids to perform respective operation.
- Complete stack - hardware and software - designed and built in India
- Provision for expansion of the relevant file name of alarm video, etc
- Provides real-time analogue output.
- The system can store the driver's real-time driving behaviour into a high-speed TF



64. AI-Based Lighting Control system on HEMM (Heavy Earth Moving Machinery)

The Smart Lighting control system is an Artificial Intelligence (AI) system to control lighting circuits based on the light present in the surrounding. Depending on the ambient condition or poor visibility, the system senses and decides to switch the lights ON or OFF, without operator intervention. The system uses AI for human detection and turns on the equipment lights when a person approaches the equipment to ensure adequate illumination for operator to climb up to the equipment safely.

The AI system running on the 6 cameras engineered around the machine can perform the following actions:

- Depending on the lighting conditions control the lamps to ensure proper illumination with minimum power consumption.
- Detect the light and visibility condition in the surrounding environment and automatically control the lamps to ensure safe operations for the operator.
- Detect the presence and distance of a person behind the machine especially in the blind spot areas to ensure the safety of people working in close proximity of the machine.
- AI is also used in the seamless stitching of the videos coming from 6 cameras to create a 360-degree view.



Key Features:

- Automatic control of lights based on weather conditions and human presence.
- Detect humans and their distance from the machine with a high level of accuracy and autonomously control the machine.
- 360 degree bird-eye view around the machine in a single frame.
- The operator is informed about the Violations/Error reported by the system or the machine via a vernacular audio interface.
- The system also provides continuous monitoring of machine bucket and boom operations through real time streaming of video feeds/images with date and time stamp to check / reduce the abuse of bucket attachment during operation.

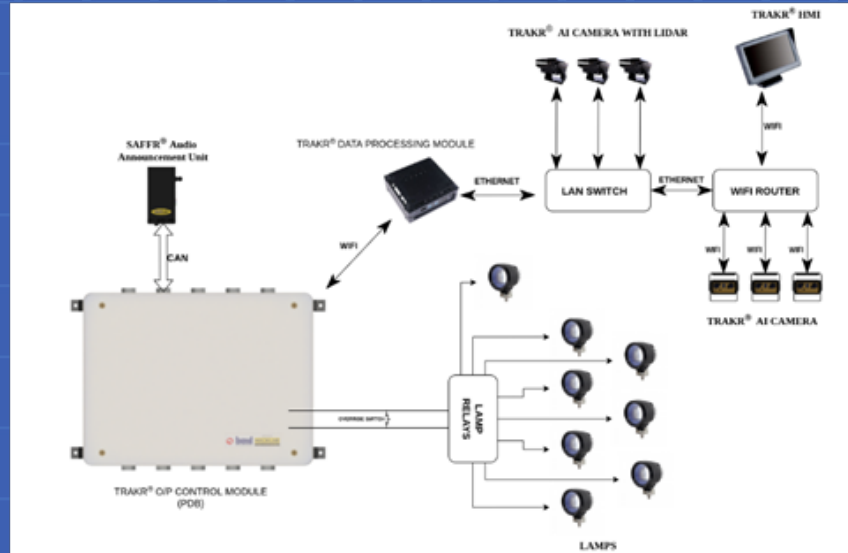

65. AI-Enabled Weld Inspection Machine with Computerized Radiography-(AI-RT)

An AI-enabled RT tool is the replacement of X-ray film technique that is used currently in conventional radiography for weld inspection. This is a safe, rapid, reliable simulation-assisted automation which is developed using Artificial Neural Networks (ANN)/Support Vector Machines (SVM)/Convolutional Neural Network (CNN) for automated defect recognition on the Digital X-ray images.

Unique Features:

- No darkroom conditions, chemical or consumables is required
- Short processing time
- Digital films can be stored in computers, cloud or remote network servers
- Efficient archiving of the data with no degradation of the quality of the image.
- Digital films cannot be tampered, ensuring more reliable data
- Very cheap considering the re-usability
- Environment friendly

SALIENT FEATURES:

- The product is usable in any steel fabrication Industry making it suitable for the domestic and international market.
- Considering the time saving in processing the information with AI enablement, the product is highly recommended for usage in shipbuilding and any other steel fabrication Industry.



66. AI-Enabled Weld Inspection Machine with Advanced Phased Array Ultrasound Technique-(AI-UT)

This AI-enabled UT tool employs a safe and rapid advanced phased array ultrasound technique using Full Matrix Capture/ Total Focusing Method approach (FMC/TFM) tools. It is augmented with AI data analytics.

This can replace X-ray techniques that are used generally for weld inspection. Phased Array Ultrasonic Testing (PAUT) is employed in this tool, which is an advanced nondestructive examination technique that utilises a set of ultrasonic testing (UT) probes made up of numerous small elements, each of which is pulsed individually with computer-calculated timing.

MAIN FUNCTIONALITIES:

- Portable
- Able to detect and obtain the images of defects based on the physics of ultrasonic waves in welded structures
- Perform robotic weld inspection in area where accessibility is limited. This reduces the requirement of scaffoldings and saves time & cost
- Perform automated evaluation of defect detection using AI-based tools
- Safe and quick
- Ease for test set-up
- Rapid inspections with digital recording of data

SALIENT FEATURES:

- The product is usable in any steel fabrication industry making it suitable for the domestic and international market.
- Considering the time saving in processing the information with AI enablement, the product is highly recommended for usage in shipbuilding and any other steel fabrication Industry.

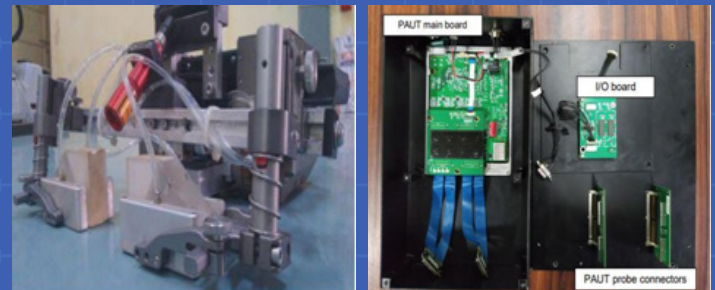

67. AI-Based Automated Bore Cleaning

The performance and life of artillery is both important and critical and as such, weapons have to be ready 24x7. This AI-based technology facilitates an automated inspection and cleaning of large calibre artillery and tank guns. An AI-vision enabled, robotic cleaning system is available for large guns.

Unique Features:

- Fully automated robotic cleaning system.
- AI-assisted vision inspection of bore surface
- Designed to operate in harsh environments
- Flexible cleaning system for rifled and smooth barrels
- Adaptable as per gun service stage
- Effortless and effective cleaning
- Can run on any power outlet or battery, ensuring flexibility.
- AI vision can detect and localize surface defects and unclean patches.



68. Brainbox

The structural integrity of gun barrels, missile launchers and rocket launcher barrels have a direct impact on the safety of men and equipment of the Armed Forces. At present, akin to other material structures there is no method which quantitatively measures the fatigue of such equipment and predict residual life.

Brainbox Spica is AI technology that can be customised to undertake structural integrity analysis of various types of metal structures and fittings.

For e.g., it can assess the structural integrity of various critical components of Guns of multiple calibres and also rocket Launcher Barrels and their components as these are subject to high levels of stress and temperature variations.

The current form of analysis can only measure thickness at random locations, pitting, etc. It cannot detect subsurface cracks or predict residual life based on actual wear and tear. It entails change of barrels on firing of a specified number of rounds, irrespective of their condition whether good or bad. Further, it also means continued usage of barrels that



may have experienced excessive damage and may be unsuitable for use.

Brainbox Spica can be utilized to assess the structural integrity and anomalies of barrels and components of weapons systems at the time of installation and during routine inspection. Useful for all the armed forces.

Benefits

- High Battle readiness
- Spares can be forecasted and budgeted accordingly based on criticality of failure
- Only Good usable Condition Ordnances & Munitions will reach the field ensuring complete preparedness in warfare.
- Reduce the overall cost of maintenance of ordinance & munitions (even other assets).
- The Prescriptive data will help improve the specifications of initial asset acquisition and/or defense production based on the real useful life information of the assets.
- Defense Exports, as SPICA can be exported to all friendly Nations & allies

Unique features:

- It's a deep learning system with mounted AI Algorithms

for detection of metallic cracks and anomalies

- Real-time inspection and assessment capability
- Detects anomalies of structures such as cracks, dents, erosion, etc.
- Detects anomalies of structures such as surface cracks, dents, erosion, etc.
- Can detect and automatically reject components which are unacceptable or unhealthy
- Reduce Downtime and Increase availability of the asset with periodic health assessment
- Eliminates intuitive inspections
- Can be deployed at production or maintenance stage based on the place of usage



A decorative background pattern of light purple circuit board traces and nodes, extending from the left and right edges towards the center, framing a central dark purple banner.

Simulators / Test Equipment

69. Development of Artificial Intelligence-based training modules for technicians for operation and maintenance of SU – 30 MKI aircraft

Parallax Labs is currently working with HAL to build a Virtual Reality & Artificial Intelligence powered training solution for operation and maintenance of Sukhoi SU-30 MKI Aircraft. The solution shall enable the operators to take up the most challenging procedures for hands-on virtual training with real-time rectification and performance analytics. The AI model accurately evaluates the corrective repair actions taken by the trainee while comparing it with historical data to deliver compelling performance reports.





**Speech / Voice Analysis Systems
using Natural Language Processing**



70. AI-Based Mandarin Translators

In order to develop indigenous capability, the Indian Army has been focusing on multiple domains to leverage AI. In the domain of Natural Language Processing (NLP), it has focused on an AI-based Bi-directional Mandarin to English Wearable Translation device.

Device Capability.

The device is a wearable device for speech-to-speech translation. It equips intelligence agencies with a bi-directional speech-to-speech system that accepts input audio/speech in one source language (e.g., English/Mandarin) and converts it into an equivalent audio/speech of the target language (e.g., Mandarin/English). The portable translation device has real time bi-directional speech capability, without any rearward network connectivity. It weighs 80-100 gms, with a latency of 3-4 secs and a battery life of 12 hrs.

The system consists of wearable devices, docking stations and re-training servers. It is the wearable translation device on the tactical edge and completely disconnected from any network.

The potential usage is during meetings, engagements etc.

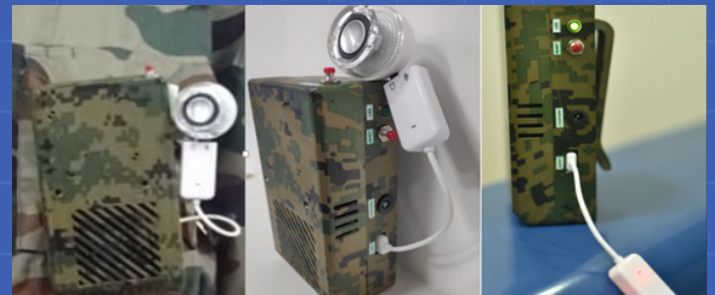
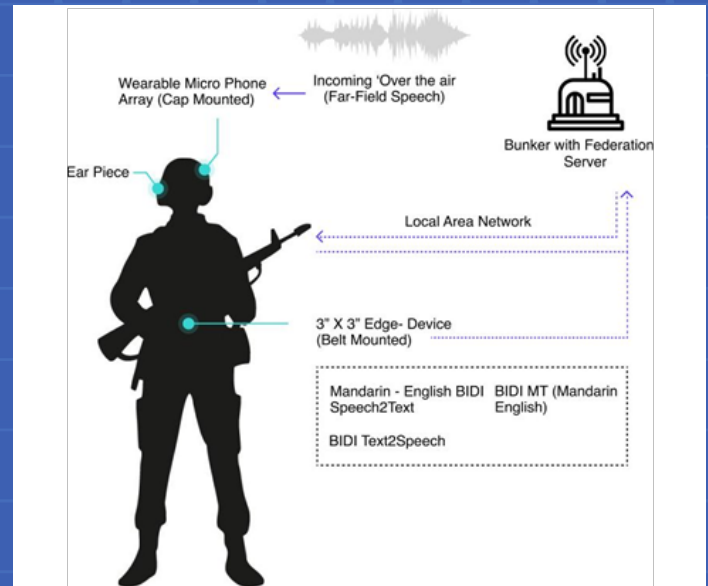

71. AI-Based Offline Language Translator

It's the only solution in India wherein a GPU-based algorithm can be deployed in a CPU-based hardware. Further, being offline, it does not entail any kind of dependency.

Its ability to be deployed in a CPU-based system algorithm, means it can be used for field trails, or in a remote location through a hand-held mobile device.

72. Speech-to-Speech Translation

The Speech-to-Speech translation is a difficult problem to solve due to understanding of how different people speak with different clarity, accents, speed etc. compounded by noise from ambient environment. This problem is made more challenging by requirement of huge corpus required to cover large vocabularies for translation to give a good quality output. The Speech-to-Speech translation system developed for English to Hindi translation is able to perform well under such conditions.

The objective of the development of Speech-to-Speech translation system is to generate real-time speech translation in the target language. The system will enable the understanding of source language without the requirement of a translator. This will reduce the requirement of translators and also reduce cognitive load put on translator. Since the system works in real time it will be capable of enabling communication also. The objective of the English to Hindi Speech to Speech translation system is to enable Hindi speaking people (528 million) who are unable to understand English.

The system can be deployed in places where interaction between people of different language speaking regions is frequent. Also, it can be used to understand recorded speech in different language.

Since the system is developed in a modular fashion, the modules of speech recognition, translation and generation of speech can also be used independently. Thus, serving different use cases.

Unique Features:

- No internet connectivity required
- No dependence on third-party APIs or cloud services
- Comprehension of Indian accents
- Generation of natural Hindi speech

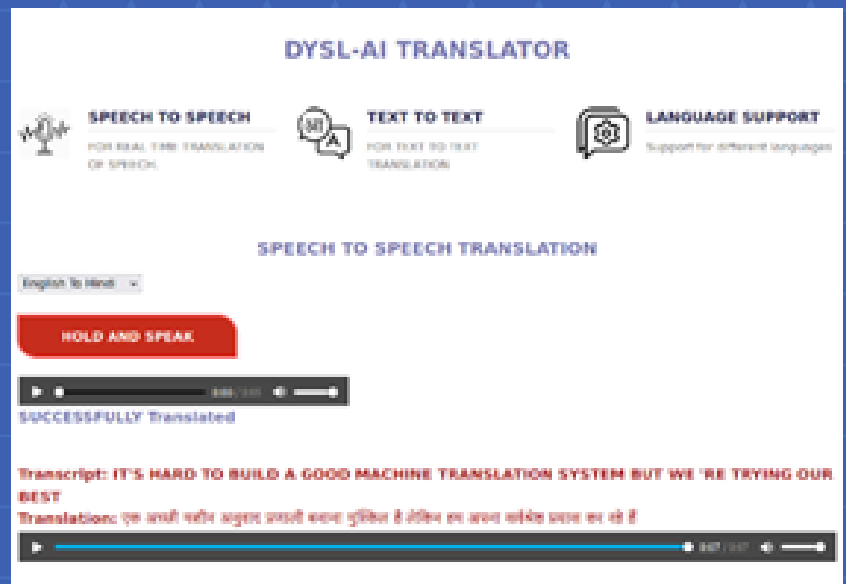

73. AI-Enabled Voice Transcription Software

Being able to intercept and identify audio data, particularly voice, can be vital to security and surveillance.

This software is an integrated module of the Communication Intelligence (COMINT) system. The Speaker and Language Identification module serves as a definite value addition towards voice surveillance on audio data intercepted by the following:

The solution is deployed at the pilot site (Jamnagar) of Signal Intelligence (SI) Navy. It works uniquely by applying speaker and language recognition functionalities to explore the capability of revealing significant insights into the dynamics of hidden communication. Particularly, the speaker and language details identified by the system can easily be targeted by law enforcement and security agencies for analysing covert networks.

Innovative features:

- Voice activity detection
- Speaker identification
- Language identification
- Keyword spotting
- Continuous speech conversion
- Speech Enhancement/ Audio Editing
- Dialect Identification
- Speaker Diarisation

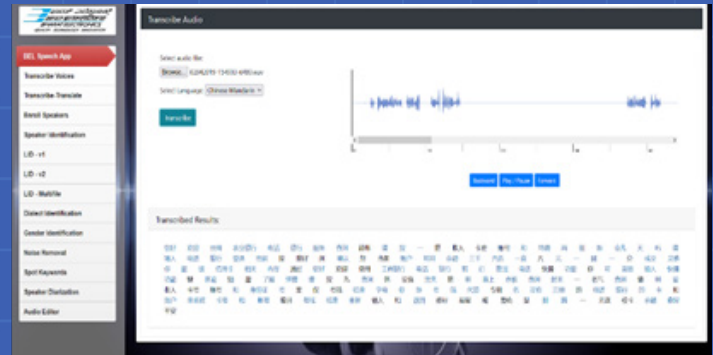
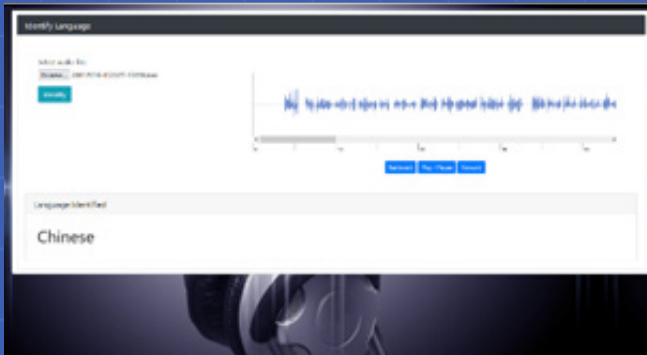

74. Voice Activated Command System (VACS)

Modern Combat aircraft consists of various sensors like RADAR, Data Link, EO Pod etc., which provide a large amount of information in real time. Pilots have to fly their missions and simultaneously correlate all the sensor information in real time for decision making.

VACS recognises the voice commands of the pilot and send the recognised voice command codes to the mission computer for carrying out the Pilot's intended action.

VACS will be used for tuning of radios, selection of modes, setup of MFDs, navigational equipment etc.

Unique Features:

- Voice Activated Command System recognises pilot voice commands using AI-based Speech Recognition technology. It is the first of its kind to be used in a cockpit of an airborne platform.
- It can correctly recognise voice commands even with the cockpit noise of 110 dB (loudness equivalent to a riveting machine or a jackhammer)

Utility

- Only a limited numbers of controls are available on the Hands-On Throttle And Stick (HOTAS) to enable the pilot to fly the aircraft and simultaneously command the sensors or initiate actions without removing his hands from the flying controls.
- AI-based Voice activated command system (VACS) will help to reduce pilot workload and enhance effectiveness in combat situation and allows pilot to

focus more on the critical tasks such as engaging threats, landing, terrain etc. as movement of hand from HOTAS to Display devices will be eliminated.

Marketability & Export Potential

- VACS has been validated and integrated on Hawk-i platform.
- It is proposed to be integrated in Su-30 Upgrade and AMCA aircraft as part of Integrated Audio Management System (IAMS)
- VACS can be packaged with the fighter platform sales being targeted by HAL to friendly countries.

75. AI-Powered Language Translation Platform

The BLADe-S ISR platform is an indigenously built, fully-integrated Artificial Intelligence (AI) based platform capable of processing all major forms of intelligence data – audio, video, text and images.

The platform enables intelligence analysts to review input data, analyse and then tag intercepts based on criticality. An in-built reporting engine provides custom reports to senior leadership enabling data driven decisions.

BLADe-S is the wearable version of the system - an AI based offline real time wearable language translation platform powered by Edge computing devices with AI speech analytics and NLP.

Built in Neural network processor with federated learning and on field adaptation capabilities Due to small footprint, zero connectivity the device is almost unobtrusive. The device can be used by intelligent agencies and frontline positioned units to decode the foreign language messaging.

Unique features:

- Wearable language translator with AI speech analytics and NLP
- Built in Neural Network Processor to compute & offer real time translation using Edge computing device
- Federated Learning (Distributed & Private – no movement of Data) & Adaptation on Field
- 2 mode operation- Unidirectional (Mandarin to English) & Bidirectional (Mandarin to English and viceversa)
- Supports Russian and other 11 local languages
- Lithium ion battery 6-8 hours back-up in standard & harsh operating conditions
- Memory: Can record up to 400 hours of data. 10 seconds of voice gets converted into a voice file of approx. size few kbs
- For full day recording- Approx. data size is 500-600mb
- Total memory space available is 64 Gb SC Card- 43 Gb is for application. 19 Gb available for recorder
- Memory full- 8/12 hrs memory dump can be done



The logo features a large white '75' with a stylized Indian tricolor (saffron, white, and green) and the Ashoka Chakra integrated into the '5'. Below this, the text 'Azadi Ka Amrit Mahotsav' is displayed in a sans-serif font, with 'Azadi' in orange, 'Ka' in white, 'Amrit' in white, and 'Mahotsav' in green.

75
Azadi Ka
Amrit Mahotsav

